



IntuitionTM
Metal Finishing Controller

Instruction Manual

W A L C H E M

IWAKI America Inc.

Notice

© 2022 WALCHEM, Iwaki America Incorporated (hereinafter “Walchem”)
5 Boynton Road, Holliston, MA 01746 USA
(508) 429-1110
All Rights Reserved
Printed in USA

Proprietary Material

The information and descriptions contained herein are the property of WALCHEM. Such information and descriptions may not be copied or reproduced by any means, or disseminated or distributed without the express prior written permission of WALCHEM, 5 Boynton Road, Holliston, MA 01746.

This document is for information purposes only and is subject to change without notice.

Statement of Limited Warranty

WALCHEM warrants equipment of its manufacture, and bearing its identification to be free from defects in workmanship and material for a period of 24 months for electronics and 12 months for mechanical parts and electrodes from date of delivery from the factory or authorized distributor under normal use and service and otherwise when such equipment is used in accordance with instructions furnished by WALCHEM and for the purposes disclosed in writing at the time of purchase, if any. WALCHEM's liability under this warranty shall be limited to replacement or repair, F.O.B. Holliston, MA U.S.A. of any defective equipment or part which, having been returned to WALCHEM, transportation charges prepaid, has been inspected and determined by WALCHEM to be defective. Replaceable elastomeric parts and glass components are expendable and are not covered by any warranty.

THIS WARRANTY IS IN LIEU OF ANY OTHER WARRANTY, EITHER EXPRESS OR IMPLIED, AS TO DESCRIPTION, QUALITY, MERCHANTABILITY, FITNESS FOR ANY PARTICULAR PURPOSE OR USE, OR ANY OTHER MATTER.

180762 Rev. A April 2022

walchem.com

Contents

1.0 INTRODUCTION	1
2.0 SPECIFICATIONS	3
2.1 Measurement Performance	3
2.2 Electrical: Input/Output	5
2.3 Intended Use	6
2.4 Mechanical.....	6
2.5 Variables and their Limits.....	7
3.0 UNPACKING & INSTALLATION	10
3.1 Unpacking the unit	10
3.2 Mounting the electronic enclosure	10
3.3 Immersible Copper Sensor Installation	10
3.4 Flow Through Copper Sensor/Sample Loop Installation	11
3.5 Flow Through Nickel Sensor/Sample Loop Installation	11
3.6 Other Sensor Installation	13
3.7 Icon Definitions	18
3.8 Electrical installation	18
4.0 FUNCTION OVERVIEW	34
4.1 Front Panel	34
4.2 Touchscreen	34
4.3 Icons	34
4.4 Startup	36
4.5 Shut Down	38
5.0 OPERATION using the touchscreen	39
5.1 Alarms Menu	47
5.2 Inputs Menu	47
5.2.1 Copper/Nickel	50
5.2.2 Contacting Conductivity	51
5.2.3 Electrodeless Conductivity	52
5.2.4 Temperature	53
5.2.5 pH.....	53
5.2.6 ORP.....	54
5.2.7 Disinfection.....	54
5.2.8 Generic Sensor	55
5.2.9 Transmitter Input and AI Monitor Input	55
5.2.10 Fluorometer Input.....	56
5.2.11 Analog Flowmeter Input.....	56

5.2.12	DI State	57
5.2.13	Flow Meter, Contactor Type.....	58
5.2.14	Flow Meter, Paddlewheel Type.....	58
5.2.15	Feed Monitor	59
5.2.16	DI Counter Input.....	61
5.2.17	Virtual Input – Calculation.....	61
5.2.18	Virtual Input – Redundant.....	62
5.2.19	Virtual Input – Raw Value	63
5.3	Outputs Menu	64
5.3.1	Relay, Any Control Mode	64
5.3.2	Relay, On/Off Control Mode	64
5.3.3	Plating Control.....	65
5.3.4	Plating Follow	66
5.3.5	Relay, Percent Timer Control Mode.....	66
5.3.6	Relay, Alarm Output Mode.....	66
5.3.7	Relay, Time Proportional Control Mode.....	67
5.3.8	Relay, Manual Mode.....	67
5.3.9	Relay, Pulse Proportional Control Mode.....	67
5.3.10	Relay, PID Control Mode	68
5.3.11	Relay, Dual Set Point Mode.....	70
5.3.12	Relay, Timer Control Mode	71
5.3.13	Relay, Probe Wash Control Mode	73
5.3.14	Relay, Spike Control Mode	73
5.3.15	Relay Output, Flow Meter Ratio Control Mode	75
5.3.16	Relay Output, Flow Proportional Mode	75
5.3.17	Relay, Counter Timer Control Mode	76
5.3.18	Relay, Dual Switch Control Mode.....	76
5.3.19	Relay or Analog Output, Lag Control Mode	77
5.3.20	Analog Output, Retransmit Mode	83
5.3.21	Analog Output, Proportional Control Mode.....	83
5.3.22	Analog or Relay Output, PID Control Mode.....	83
5.3.23	Analog Output, Manual Mode.....	86
5.4	Configuration Menu	87
5.4.1	Global Settings	87
5.4.2	Security Settings.....	87
5.4.3	Ethernet Settings.....	88
5.4.4	Ethernet Details	89
5.4.5	Remote Communications (Modbus and BACnet).....	89
5.4.6	Email Report Settings.....	90
5.4.7	Display Settings.....	91
5.4.9	Controller Details	92

5.5 HOA Menu	93
5.6 Graph Menu	93
6.0 OPERATION using Ethernet	94
6.1 Connecting to a LAN.....	94
6.1.1 Using DHCP	95
6.1.2 Using a fixed IP Address	95
6.2 Connecting Directly to a Computer.....	95
6.3 Navigating the web pages	95
6.4 Graphs Webpage.....	96
6.5 Software Upgrade.....	96
7.0 MAINTENANCE	97
7.1 Copper or Nickel Sensor Cleaning	97
7.2 pH Electrode Maintenance	98
8.0 TROUBLESHOOTING	98
8.1 Calibration Failure	99
8.1.1 Copper or Nickel Sensors	99
8.1.2 pH Sensors.....	99
8.1.3 Contacting Conductivity Sensors	99
8.1.4 Electrodeless Conductivity Sensors	99
8.1.5 ORP Sensors	100
8.1.6 Disinfection Sensors.....	100
8.1.7 Analog Inputs	100
8.1.8 Temperature Sensors	101
8.2 Alarm Messages	101
8.3 Procedure for Evaluation of Conductivity Electrode	105
8.4 Procedure for evaluation of the pH/ORP electrode	106
8.5 Diagnostic Lights	106
9.0 Spare Parts Identification	107
10.0 Service Policy	108

1.0 INTRODUCTION

The Walchem Intuition-6™ Series controllers offer a high level of flexibility in controlling metal finishing applications.

One or two sensor inputs are available that are compatible with a variety of sensors:

- Single Copper or Nickel plus Single pH
- Dual Analog (4-20 mA) Input
- Single Analog Input + Single Sensor (Contacting Conductivity, pH, ORP, Disinfection or Generic linear voltage between -2 and 2 VDC)
- Sensor Input (Electrodeless Conductivity, Contacting Conductivity, pH, ORP, Disinfection or Generic linear voltage between -2 and 2 VDC)

An analog (4-20 mA) sensor input card with two input circuits is also available for use with 2,3 or 4-wire transmitters. Or a sensor card that combines one sensor (contacting conductivity, pH, ORP, disinfection or generic) plus one analog (4-20 mA) input is available.

Six Virtual Inputs are configurable in the software, to either allow for calculations based on two real inputs, or to allow to compare values from two sensors to provide redundancy.

Six relay outputs may be set to a variety of control modes:

- Plating Control
- Plating Follow
- Flow Timer
- On/Off set point control
- Time Proportional control
- Pulse Proportional control (when purchased with Pulse solid state opto outputs)
- PID control (when purchased with Pulse solid state opto outputs)
- Lead/Lag control of up to 6 relays
- Dual set point
- Timer
- Feed as a percent of elapsed time
- Always on unless interlocked
- Probe Wash timer
- Spike to alternate set point on timed basis
- Flow Meter Ratio
- Counter Timer
- Dual Switch
- Diagnostic Alarm triggered by:
 - High or Low sensor reading
 - No Flow
 - Relay output timeout
 - Sensor error

Relays are available in several combinations of powered relays, dry contact relays, and pulse solid state opto relays.

Six virtual Control Outputs are configurable in the software, using most of the possible relay or analog output control algorithms, that may be used to interlock or activate actual control outputs.

An option card with two isolated analog outputs may be installed to retransmit sensor input signals to a chart recorder, datalogger, PLC or another device. They may also be connected to valves, actuators or metering pumps for linear proportional control, flow proportional or PID control.

An Ethernet option provides remote access to the controller's programming via a PC connected directly, via a local area network, or via the Walchem Fluent account management server. It also allows emailing of datalog files (in CSV format, compatible with spreadsheets like Excel) and alarms, to up to eight email addresses. The Modbus TCP and BACnet remote communications options allow communication with PC-based applications, HMI/SCADA programs, Building Energy Management systems, Distributed Control Systems (DCS), as well as stand-alone HMI devices.

Our USB features provide the ability to upgrade the software in the controller to the latest version. The Config file feature allows you to save all the set points from a controller onto a USB flash disk, and then import them into another controller, making the programming of multiple controllers fast and easy. The data logging feature allows you to save the sensor readings and relay activation events to a USB flash disk.

2.0 SPECIFICATIONS

2.1 Measurement Performance

Sensor Specs			
Copper			
Range	0.10 to 99 g/l (varies with the chemical being measured) 0.10 to 5.50 g/l typical for electroless copper		
Resolution	0.01 g/l		
Accuracy	± 0.01 g/l		
Nickel			
Range	0.10 to 25 g/l (varies with the chemical being measured)		
Resolution	0.01 g/l		
Accuracy	± 0.01 g/l		
0.01 Cell Contacting Conductivity			
Range	0-300 µS/cm		
Resolution	0.01 µS/cm, 0.0001 mS/cm, 0.001 mS/m, 0.0001 S/m, 0.01 ppm		
Accuracy	± 1% of reading or 0.01 µS/cm, whichever is greater		
0.1 Cell Contacting Conductivity			
Range	0-3,000 µS/cm		
Resolution	0.1 µS/cm, 0.0001 mS/cm, 0.01 mS/m, 0.0001 S/m, 0.1 ppm		
Accuracy	± 1% of Reading or 0.1 µS/cm, whichever is greater		
1.0 Cell Contacting Conductivity			
Range	0-30,000 µS/cm		
Resolution	1 µS/cm, 0.001 mS/cm, 0.1 mS/m, 0.0001 S/m, 1 ppm		
Accuracy	± 1% of Reading or 1 µS/cm, whichever is greater		
10.0 Cell Contacting Conductivity			
Range	0-300,000 µS/cm		
Resolution	10 µS/cm, 0.01 mS/cm, 1 mS/m, 0.001 S/m, 10 ppm		
Accuracy	± 1% of Reading or 10 µS/cm, whichever is greater		
pH			
ORP/ISE			
Range	-2 to 16 pH units	Range	-1500 to 1500 mV
Resolution	0.01 pH units	Resolution	0.1 mV
Accuracy	± 0.01% of reading	Accuracy	± 1 mV
Disinfection Sensors			
Range (mV)	-2000 to 1500 mV	Range (ppm)	0-2 ppm to 0-20,000 ppm
Resolution (mV)	0.1 mV	Resolution (ppm)	Varies with range and slope
Accuracy (mV)	± 1 mV	Accuracy (ppm)	Varies with range and slope

100Ω RTD Temperature		
Range	23 to 500°F (-5 to 260°C)	
Resolution	0.1°F (0.1°C)	
Accuracy	± 1% of Reading or ± 1°C, whichever is greater	
1000Ω RTD Temperature		
Range	23 to 500°F (-5 to 260°C)	
Resolution	0.1°F (0.1°C)	
Accuracy	± 1% of Reading or ± 0.3°C , whichever is greater	
10k or 100k Thermistor Temperature		
Range	23 to 194°F (-5 to 90°C)	
Resolution	0.1°F (0.1°C)	
Accuracy	± 1% of Reading or ± 0.3°C, whichever is greater	
Analog (4-20 mA)		
Range	0 to 22 mA	
Resolution	0.01 mA	
Accuracy	± 0.5% of reading	
Electrodeless Conductivity		
Range	Resolution	Accuracy
500-12,000 μS/cm	1 μS/cm, 0.01 mS/cm, 0.1 mS/m, 0.001 S/m, 1 ppm	1% of reading
3,000-40,000 μS/cm	1 μS/cm, 0.01 mS/cm, 0.1 mS/m, 0.001 S/m, 1 ppm	1% of reading
10,000-150,000 μS/cm	10 μS/cm, 0.1 mS/cm, 1 mS/m, 0.01 S/m, 10 ppm	1% of reading
50,000-500,000 μS/cm	10 μS/cm, 0.1 mS/cm, 1 mS/m, 0.01 S/m, 10 ppm	1% of reading
200,000-2,000,000 μS/cm	100 μS/cm, 0.1 mS/cm, 1 mS/m, 0.1 S/m, 100 ppm	1% of reading

Temperature °C	Range Multiplier
0	181.3
10	139.9
15	124.2
20	111.1
25	100.0
30	90.6
35	82.5
40	75.5
50	64.3
60	55.6
70	48.9

Temperature °C	Range Multiplier
80	43.5
90	39.2
100	35.7
110	32.8
120	30.4
130	28.5
140	26.9
150	25.5
160	24.4
170	23.6
180	22.9

Note: Conductivity ranges on page 2 apply at 25°C. At higher temperatures, the range is reduced per the range multiplier chart.

2.2 Electrical: Input/Output

Input Power	100 to 240 VAC, 50 or 60 Hz, 7 A maximum Fuse: 6.3 A
Inputs	
<i>Copper/Nickel Sensor Signals (0, 1 or 2 depending on model code):</i>	
Copper	Walchem 190787 immersible OR 190785, 190893, 191596 flow through sensors
Nickel	Walchem 190784 flow through sensor
<i>Sensor Input Signals (0, 1 or 2 depending on model code):</i>	
Contacting Conductivity	0.01, 0.1, 1.0, or 10.0 cell constant OR
Electrodeless Conductivity	(not available on the combination sensor/analog input card) OR
Disinfection	OR
Amplified pH, ORP or ISE	Requires a preamplified signal. Walchem WEL or WDS series recommended. ±5VDC power available for external preamps.
Each sensor input card contains a temperature input	
Temperature	100 or 1000 ohm RTD, 10K or 100K Thermistor
<i>Analog (4-20 mA) Sensor Input (0, 1, 2 or 4 depending on model code):</i>	2-wire loop powered or self-powered transmitters supported 3 or 4 –wire transmitters supported Each dual sensor input board has two channels Channel 1, 130 ohm input resistance Channel 2, 280 ohm input resistance The combination input board has one channel, 280 ohm input resistance Available Power: One independent isolated 24 VDC ± 15% supply per channel 1.5 W maximum for each channel 2W (83 mA at 24 VDC) total power consumption for all channels (four total channels possible if two dual boards are installed; 2W is equivalent to 2 Little Dipper sensors)
Digital Input Signals (6):	
<i>State-Type Digital Inputs</i>	Electrical: Optically isolated and providing an electrically isolated 9V power with a nominal 2.3mA current when the digital input switch is closed Typical response time: < 2 seconds Devices supported: Any isolated dry contact (i.e. relay, reed switch) Types: Interlock
<i>Low Speed Counter-Type Digital Inputs</i>	Electrical: Optically isolated and providing an electrically isolated 9VDC power with a nominal 2.3mA current when the digital input switch is closed 0-20 Hz, 25 msec minimum width Devices supported: Any device with isolated open drain, open collector, transistor or reed switch Types: Contacting Flowmeter, Flow Verify
<i>High Speed Counter-Type Digital Inputs</i>	Electrical: Optically isolated and providing an electrically isolated 9VDC power with a nominal 2.3mA current when the digital input switch is closed, 0-500 Hz, 1.00 msec minimum width, Minimum pulse rate to see paddlewheel rate = 0.17 Hz Devices supported: Any device with isolated open drain, open collector, transistor or reed switch Types: Paddlewheel Flowmeter, DI Counter
Note: Total available power on the Digital Input 9 VDC is 111 mA	

Outputs	
Powered mechanical relays (0 or 6 depending on model code):	Pre-powered on circuit board switching line voltage 6 A (resistive), 1/8 HP (93 W) All six relays are fused together as one group, total current for this group must not exceed 6A
Dry contact mechanical relays (0, 2 or 4 depending on model code):	6 A (resistive), 1/8 HP (93 W) Dry contact relays are not fuse protected
Pulse Outputs (0, 2 or 4 depending on model code):	Opto-isolated, Solid State Relay 200mA, 40 VDC Max. VLOWMAX = 0.05V @ 18 mA Accuracy (0-10 Hz): ± 0.5% of Pulse Rate, (10-20 Hz): ± 1.0%, (20-40 Hz): ± 2.0%
4 - 20 mA (0 or 2)	Internally powered Fully isolated 600 Ohm max resistive load Resolution 0.0015% of span
Ethernet	10/100 802.3-2005 Auto MDIX support Auto Negotiation
USB	Connector: Type A receptacle Speed: High speed (480 Mbit) Power: 0.5 A maximum
Battery (Real-Time Clock)	Model BR2032, 3-volt Lithium Coin Cell 20 mm diameter
Agency Approvals:	
EMC	UL 61010-1:2012 3rd Ed + Rev:2019 CSA C22.2 No. 61010-1:2012 3rd Ed. + U1; U2 IEC 61010-1:2010 3rd Ed. + A1:2016 EN 61010-1:2010 3rd Ed. + A1:2019 BS EN 61010-1:2010 + A1:2019
EMC	IEC 61326-1:2020 EN 61326-1:2013 BS EN 61326-1:2013
<p>For EN 61000-4-3 Radiated RF Immunity, the controller meets Performance Criteria B. In environments where severe radio-frequency interference (RFI) is present, the controller may reboot/restart. If this occurs, the controller should be relocated away from the electromagnetic interference (EMI) source.</p> <p>*Class A equipment: Equipment suitable for use in establishments other than domestic, and those directly connected to a low voltage (100-240 VAC) power supply network which supplies buildings used for domestic purposes.</p>	

2.3 Intended Use

The Walchem Intuition-6 is a microprocessor-based measuring and control instrument used to measure water quality parameters and other process variables in a wide range of water and wastewater treatment applications. Operating the instrument in any way other than as described in these instructions may compromise the safety and function of the measuring system and is therefore impermissible. Electrical connection work and maintenance work may only be carried out by qualified personnel. The manufacturer is not liable for damage caused by improper or non-designated use.

2.4 Mechanical

Enclosure Material	Polycarbonate
Enclosure Rating	NEMA 4X (IEC 60529 to IP66)
Dimensions	11.1" x 8.3" x 5.5" (282 mm x 211 mm x 140 mm)

Display	5" TFT color display, 800 x 480 pixels with capacitive touchscreen
Operating Ambient Temp	-4 to 131 °F (-20 to 55 °C)
Storage Temperature	-4 – 176°F (-20 – 80°C)
Humidity	10 to 90% non-condensing

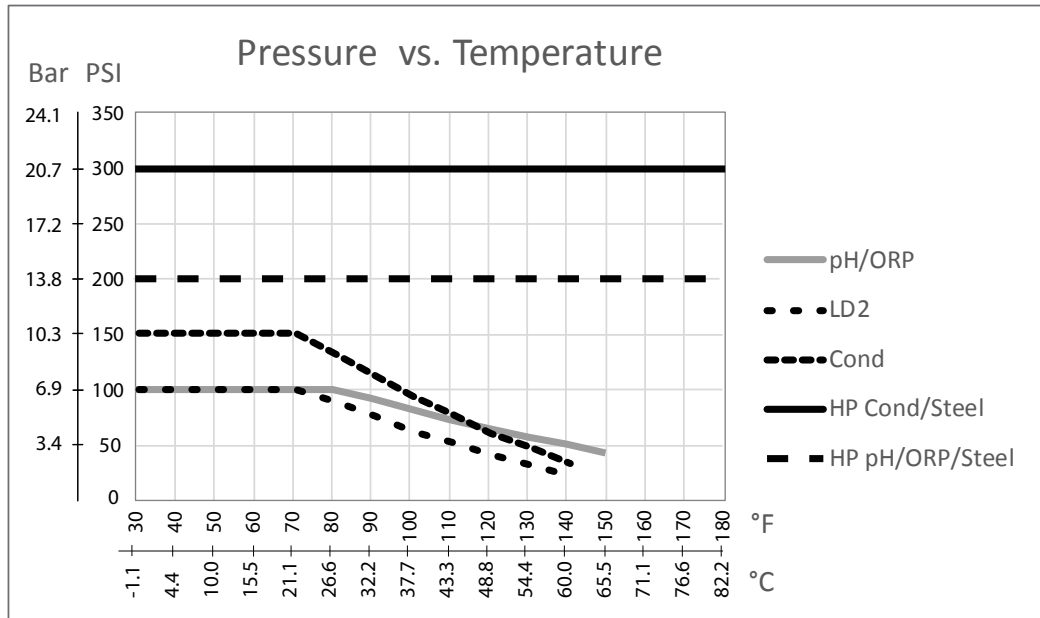

2.5 Variables and their Limits

Sensor Input Settings	Low Limit	High Limit
Calibration Offset (Copper or Nickel only)	-10 g/l or oz/gal	10 g/l or oz/gal
Stabilization Time (Copper or Nickel only)	0:00 minutes	59:59 minutes
Alarm limits	Low end of sensor range	High end of sensor range
Input alarm dead band	Low end of sensor range	High end of sensor range
Cell constant (conductivity only)	0.01	10
Smoothing Factor	0%	90%
Temp Comp Factor (conductivity linear ATC only)	0%	20.000%
Installation Factor (Electrodeless conductivity only)	0.5	1.5
Cable length	0.1	3,000
PPM conversion factor (only if units = PPM)	0.001	10.000
Default temperature	-20	500
Deadband	Low end of sensor range	High end of sensor range
Calibration Required Alarm	0 days	365 days
Sensor Slope (Generic sensor only)	-1,000,000	1,000,000
Sensor Offset (Generic sensor only)	-1,000,000	1,000,000
Low Range (Generic sensor only)	-1,000,000	1,000,000
High Range (Generic sensor only)	-1,000,000	1,000,000
4 mA value (Transmitter, AI Monitor analog input only)	0	100
20 mA value (Transmitter, AI Monitor analog input only)	0	100
Flow meter input settings	Low Limit	High Limit
Totalizer alarm	0	100,000,000
Volume/contact for units of Gallons or Liters	1	100,000

Volume/contact for units of m ³	0.001	1,000
K Factor for units of Gallons or Liters	0.01	100,000
K Factor for units of m ³	1	1,000,000
Paddlewheel rate alarm limits	0	High end of sensor range
Paddlewheel rate alarm deadband	0	High end of sensor range
Smoothing Factor	0%	90%
Set Flow Total	0	1,000,000,000
Feed Monitor Input Settings	Low Limit	High Limit
Totalizer Alarm	0 vol. units	1,000,000 vol. units
Set Flow Total	0 vol. units	1,000,000,000 vol. units
Flow Alarm Delay	00:10 Minutes	59:59 Minutes
Flow Alarm Clear	1 Contact	100,000 Contacts
Dead Band	0%	90%
Reprime Time	00:00 Minutes	59:59 Minutes
Volume/Contact	0.001 ml	1,000.000 ml
Smoothing Factor	0%	90%
Counter Input Settings	Low Limit	High Limit
DI Counter Rate Alarms	0	30,000
DI Counter Rate Deadband	0	30,000
Totalizer Alarm	0	2,000,000,000
Set Total	0	2,000,000,000
Units per Pulse	0.001	1,000
Smoothing Factor	0%	90%
Relay output settings	Low Limit	High Limit
Output Limit Time	1 second	86,400 seconds (0 = unlimited)
Hand Time Limit	1 second	86,400 seconds (0 = unlimited)
Min Relay Cycle	0 seconds	300 seconds
Set Point	Low end of sensor range	High end of sensor range
Spike Set Point (Spike mode)	Low end of sensor range	High end of sensor range
Onset Time (Spike Mode)	0 seconds	23:59:59 HH:MM:SS
On Delay Time (Manual, On/Off, Dual Setpoint modes, Dual Switch, Alarm modes)	0 seconds	23:59:59 HH:MM:SS
Off Delay Time (Manual, On/Off, Dual Setpoint modes, Dual Switch, Alarm modes)	0 seconds	23:59:59 HH:MM:SS
Dead Band	Low end of sensor range	High end of sensor range
Turnover Volume (Plating Control, Plating Follow modes)	0	10,000
Turnover Limit (Plating Control, Plating Follow modes)	0	100
Set Turnover Value (Plating Control mode)	0	100
Pump Capacity (Plating Control, Plating Follow modes)	0	1,000
Pump Setting (Plating Control, Plating Follow modes)	0%	100%
Feed duration (Flow Timer, Counter Timer mode)	0 seconds	86,400 seconds
Accumulator Setpoint (Counter Timer mode)	1	1,000,000
Accumulator Volume (Flow Timer, Target PPM, PPM Volume, Volumetric Blend, Flow Meter Ratio modes)	1	1,000,000
Event duration (Timer modes)	0	30,000
Proportional band (Time/Pulse Proportional mode)	Low end of sensor range	High end of sensor range
Sample period (Time Proportional mode)	0 seconds	3600 seconds

Hold Time (Probe Wash modes)	0 seconds	3600 seconds
Max Rate (Pulse Proportional, Pulse PID modes)	10 pulses/minute	2400 pulses/minute
Minimum Output (Pulse Proportional, Pulse PID modes)	0%	100%
Maximum Output (Pulse Proportional, Pulse PID modes)	0%	100%
Gain (Pulse PID Standard mode)	0.001	1000.000
Integral Time (Pulse PID Standard mode)	0.001 seconds	1000.000 seconds
Derivative Time (Pulse PID Standard mode)us	0 seconds	1000.000 seconds
Proportional Gain (Pulse PID Parallel mode)	0.001	1000.000
Integral Gain (Pulse PID Parallel mode)	0.001 /second	1000.000 /second
Derivative Gain (Pulse PID Parallel mode)	0 seconds	1000.000 seconds
Input Minimum (Pulse PID modes)	Low end of sensor range	High end of sensor range
Input Maximum (Pulse PID modes)	Low end of sensor range	High end of sensor range
Wear Cycle Time (Lag mode)	10 seconds	23:59:59 HH:MM:SS
Delay Time (Lag mode)	0 seconds	23:59:59 HH:MM:SS
Analog (4-20 mA) Output Settings	Low Limit	High Limit
4 mA Value (Retransmit mode)	Low end of sensor range	High end of sensor range
20 mA Value (Retransmit mode)	Low end of sensor range	High end of sensor range
Hand Output	0%	100%
Set Point (Proportional, PID modes)	Low end of sensor range	High end of sensor range
Delay Time (Lag mode)	0 seconds	23:59:59 HH:MM:SS
Bleed Volume (Flow Meter Ratio mode)	1	1,000,000
Pump Capacity (Flow Prop mode)	0 gal/hour or l/hour	10,000 gal/hour or l/hour
Pump Setting (Flow Prop mode)	0%	100%
Specific Gravity (Flow Prop mode)	0 g/ml	9.999 g/ml
Target (Flow Prop mode)	0 ppm	1,000,000 ppm
Analog (4-20 mA) Output Settings	Low Limit	High Limit
4 mA Value (Retransmit mode)	Low end of sensor range	High end of sensor range
20 mA Value (Retransmit mode)	Low end of sensor range	High end of sensor range
Hand Output	0%	100%
Set Point (Proportional, PID modes)	Low end of sensor range	High end of sensor range
Proportional Band (Proportional mode)	Low end of sensor range	High end of sensor range
Minimum Output (Proportional, PID modes)	0%	100%
Maximum Output (Proportional, PID modes)	0%	100%
Off Mode Output (Proportional, PID modes, Flow Prop modes)	0 mA	21 mA
Error Output (not in Manual mode)	0 mA	21 mA
Hand Time Limit (not in Retransmit mode)	1 second	86,400 seconds (0 = unlimited)
Output Time Limit (Proportional, PID modes)	1 second	86,400 seconds (0 = unlimited)
Gain (PID, Standard mode)	0.001	1000.000
Integral Time (PID Standard mode)	0.001 seconds	1000.000 seconds
Derivative Time (PID Standard mode)	0 seconds	1000.000 seconds
Proportional Gain (PID Parallel mode)	0.001	1000.000
Integral Gain (PID Parallel mode)	0.001 /second	1000.000 /second
Derivative Gain (PID Parallel mode)	0 seconds	1000.000 seconds
Input Maximum (PID modes)	Low end of sensor range	High end of sensor range
Pump Capacity (Flow Prop mode)	0 gal/hour or l/hour	10,000 gal/hour or l/hour
Pump Setting (Flow Prop mode)	0%	100%
Specific Gravity (Flow Prop mode)	0 g/ml	9.999 g/ml

Target (Flow Prop mode)	0 ppm	1,000,000 ppm
Configuration settings	Low Limit	High Limit
Local Password	0000	9999
Fluent update period	1 minute	1440 minutes
Fluent reply timeout	10 seconds	60 seconds
Alarm Delay	0:00 minutes	59:59 minutes
SMTP Port	0	65535
TCP Timeout	1 second	240 seconds
Auto Dim Time	0 seconds	23:59:59 HH:MM:SS
Graph settings	Low Limit	High Limit
Low axis limit	Low end of sensor range	High end of sensor range
High axis limit	Low end of sensor range	High end of sensor range

3.0 UNPACKING & INSTALLATION

3.1 Unpacking the unit

Inspect the contents of the carton. Please notify the carrier immediately if there are any signs of damage to the controller or its parts. Contact your distributor if any of the parts are missing. The carton should contain an Intuition-6™ Series controller and an instruction manual. Any options or accessories will be incorporated as ordered.

3.2 Mounting the electronic enclosure

The controller is supplied with mounting holes on the enclosure. It should be wall mounted with the display at eye level, on a vibration-free surface, utilizing all four mounting holes for maximum stability. Do not install the enclosure in a location where it will be exposed to direct sunlight. Use M6 (1/4" diameter) fasteners that are appropriate for the substrate material of the wall. The enclosure is NEMA 4X (IP66) rated. The maximum operating ambient temperature is 131°F (55°C); this should be considered if installation is in a high temperature location. The enclosure requires the following clearances:

Top: 2" (50 mm)
 Left: 8" (203 mm) (not applicable for prewired models)
 Right: 4" (102 mm)
 Bottom: 7" (178 mm)

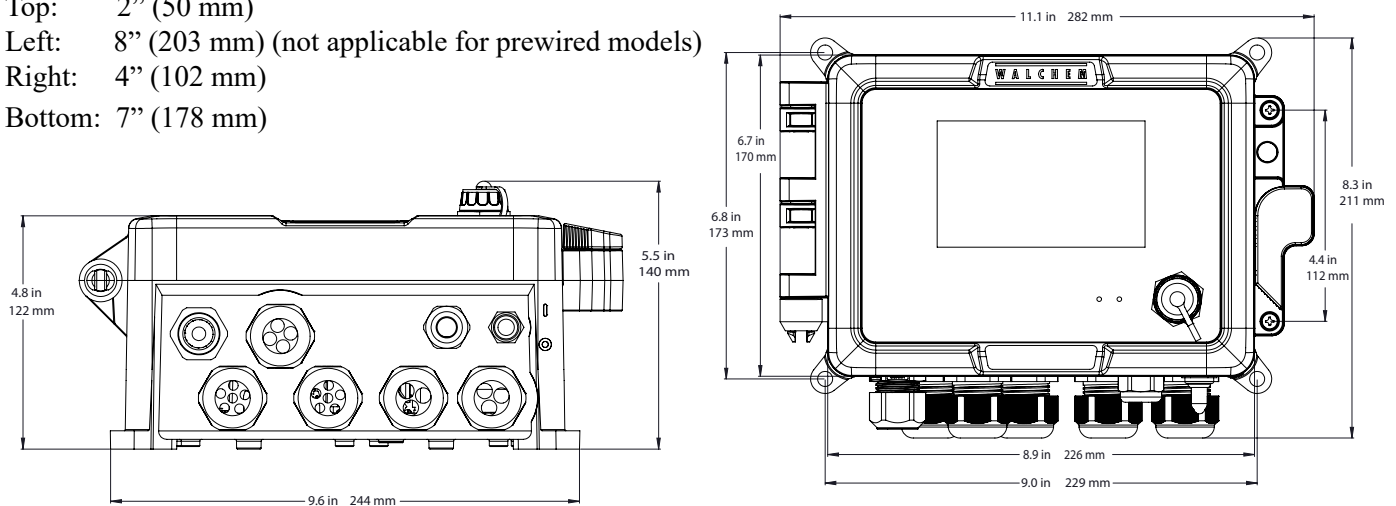

3.3 Immersible Copper Sensor Installation

The immersible copper sensor is designed for direct in-tank monitoring of electroless copper and microetch solutions. By monitoring the copper content directly in the solution, control lag and hydraulic problems are eliminated.

The sensor is constructed such that a constant path length exists between the fiber optic light guides. The solution between the light guides absorbs light at specific wavelengths in proportion to the copper concentration. The lamp and

electronics are located under the cover of the sensor. In order to avoid a shift in calibration due to condensation, the sensor's cover should NEVER be opened.

The immersible sensor is provided with a mounting plate and 20 feet of cable. Extension cable is available if the sensor cannot be mounted within 20 feet of the controller. The maximum cable length is 80 feet.

While the positioning of the sensor is not particularly sensitive to the tank layout, the following suggestions are given to aid installation:

- Do not place the sensor beside heaters; if solution flow stops, the polypropylene guard may melt.
- Do not immerse the entire sensor, or the cable.
- Place the sensor where the loads of parts will not strike it.
- Place the sensor in an area of good solution movement, but not directly in the path of any air agitation.
- Mount the sensor securely to the rim of the tank using the holes provided. If the tank is rimless, use a block to provide the support for the mounting plate.
- Attach the cable's connector to the WCU controller. The connector is keyed, do not force! The sensor you receive with the controller has already been calibrated.

3.4 Flow Through Copper Sensor/Sample Loop Installation

The copper flow through sensor is designed for out-of-tank monitoring of electroless copper and microetch solutions.

The sensor is designed with a glass tube that contains the copper solution that forms a fixed path length between the lamp and receptor module. The solution absorbs light at specific wavelengths in proportion to the copper concentration. In order to avoid a shift in calibration caused by condensation, the sensor cover should NEVER be removed!

The flow through sensor is provided with a mounting plate and 20 feet of cable. Extension cable is available if the sensor cannot be placed within 20 feet of the controller. The maximum cable length is 80 feet.

The sample loop consists of a shut off valve, a cooling coil or plate, a sensor and a pump or any combination thereof. The shut off valve is to quickly isolate the system if necessary. A cooling coil or plate is necessary to cool the copper solution down to a temperature acceptable to a sample pump. Cooling the solution is also recommended to help reduce the amount of plate out which may form in the sample loop. The pump may be either a stand alone sample pump (which typically have temperature restriction) or a high temperature pump (which is usually just a branch off the recirculation pump).

3.5 Flow Through Nickel Sensor/Sample Loop Installation

The nickel flow through sensor is designed for out-of-tank monitoring of electroless nickel solutions.

The sensor is designed with a glass tube that contains the nickel solution that forms a fixed path length between the lamp and receptor module. The solution absorbs light at specific wavelengths in proportion to the nickel concentration. In order to avoid a shift in calibration caused by condensation, the sensor cover should NEVER be removed!

The flow through sensor is provided with a mounting plate and 20 feet of cable. Extension cable is available if the sensor cannot be placed within 20 feet of the controller. The maximum cable length is 80 feet. Always route AC voltage wiring in conduit that is separated a minimum of 6 inches from low voltage DC signal lines (such as the sensor signal). The sample loop consists of a shut off valve, a cooling coil or plate, a sensor, an optional pH adapter assembly, a pump, or any combination thereof. The shut off valve is to quickly isolate the system if necessary. A cooling coil or plate is necessary to cool the nickel solution down to a temperature acceptable to a sample pump and/or pH electrode (if applicable). Cooling the solution is also recommended to help reduce the amount of plate-out that may form in the sample loop. The pH adapter assembly is used to mount an in-line pH electrode. It should be mounted such that the electrode is always immersed in the 'U' trap. The pump may be either a stand-alone sample pump (which will typically have high temperature restrictions), or a high temperature pump (which is usually a branch off of the recirculation pump).

The flow through sensor/sample loop must be installed according to the following guidelines:

- Mount the sensor on a vibration-free, vertical surface so that the sensor tubing inlet connection is at the bottom and the outlet is at the top. The vertical orientation will prevent air bubbles from being trapped in the sensor.
- Install a shut-off valve at the beginning of the sample loop so that the system may be shut off quickly if necessary.
- If a sample pump is to be used, it must be installed last, after the cooling coil or cooling plate, the flow through sensor, and the pH adapter assembly, if applicable.
- If a high temperature recirculation pump is to supply flow, adjust flow rate through the sample loop between 400 - 500 mL/min (approx. 0.11 - 0.13 gal/min). This flow rate will help ensure adequate cooling of the solution while maintaining a reasonable lagtime in longer runs of tubing. If this is not possible or is undesirable, see Application Notes below.

Other installation guidelines that may be helpful in the overall system:

- Mount the sensor as close to solution as possible. Keep tubing distances to the sensor inlet as short as possible to avoid hydraulic lag time. Maximum recommended length of tubing from solution to sensor is 25 feet. If this is not possible, see Application Notes below.
- The solution inlet should draw sample from an area of good solution movement in order to respond quickly to chemical additions. However, the solution inlet should not draw too near to where the chemistry is added to avoid artificial 'spikes' in concentration.
- The solution discharge should be open to atmospheric pressure in order to ensure proper flow.
- The cable connector to the controller is keyed, do not force!

Application Notes

If the distance from the solution to the sensor is further than the recommended length of 25 feet, the maximum lagtime must be calculated from the desired control band to determine a pump flow rate based on a given distance of standard, uniform tubing. The maximum lagtime is the maximum allowable time for the solution to continuously get to the sensor in order to achieve the desired control band.

To calculate maximum lagtime:

$$\text{Max. Lagtime} = \frac{\text{Desired Control Band}^*}{4 \times \text{Depletion Rate}}$$

where $\frac{\text{Control band} = \text{Maximum deviation of concentration}}{\text{Depletion rate} = \text{Rate at which the bath will deplete per unit of time}}$

The deadband should be adjusted so that it is 1/4 the desired control band.

For Example: The set point is 4.00 g/L.

If the desired control band is 0.20 g/L (± 0.10 g/L or 2.5%) and the bath is depleting at a rate of 1.25 g/L every 15 minutes (0.08333 g/L every minute),

$$\text{then Max. Lagtime} = \frac{0.20 \text{ g/L}}{4 \times (0.08333 \text{ g/L /min})} = 0.60 \text{ minutes}$$

So, 0.60 minutes is the maximum time it should take for the solution to reach the sensor.

To calculate pump flow rate:

$$\text{Minimum Pump Flow Rate} = \frac{\text{Volume of System}^*}{\text{Maximum Lagtime}}$$

$$\text{where Volume of system} = \frac{\pi (\text{Tubing I.D.})^2 \times \text{Length of tubing}}{2}$$

Maximum lagtime = Previously calculated time to get solution to sensor.

* Volume is based on length from solution to sensor, not the return.

For Example: If the system parameters are: Tubing is 3/8" O.D. ' 1/4" I.D.
Length is 30 feet (360 inches)

$$\begin{aligned} \text{then the volume of the system} &= \frac{\pi (0.25 \text{ in})^2 \times (360 \text{ in})}{2} \\ &= 17.7 \text{ in}^3 \end{aligned}$$

Note: 1 U.S. Gallon = 231 U.S cubic inches	1 Liter = 61.03 U.S. cubic inches
Note: Volume of Cooling Coil: 0.018 Gallons 0.068 Liters	Volume of Cooling Plate: 0.023 Gallons 0.088 Liters
Volume of 3/8" O.D. x 1/4" I.D. (0.59 in ³ /ft): 0.00255 Gallons/linear ft 0.00965 Liters/linear ft	

$$\text{Volume of the system} = \frac{17.7 \text{ in}^3}{231 \text{ in}^3 / \text{gallon}} = 0.0765 \text{ gallons}$$

Maximum lagtime = 0.60 minutes (previously calculated)

$$\text{So, the minimum pump flow rate} = \frac{0.0765 \text{ gallons}}{0.60 \text{ minutes}} = 0.127 \text{ gal/min (483 mL/min)}$$

Caution: The calculated pump flow rate is the minimum required to obtain the desired control band, however, if the flow rate increases over the recommended rate of 500 mL/min (approx. 0.13 gal/min) the rate of cooling will decrease. This may be compensated for by re-evaluating the system criteria: length / desired control band or to double up on the cooling plate/coil.

Consult factory with any further installation questions.

3.6 Other Sensor Installation

Refer to the specific instructions supplied with the sensor being used, for detailed installation instructions.

General Guidelines

Locate the sensors where an active sample of water is available and where the sensors can easily be removed for cleaning. Position the sensor such that air bubbles will not be trapped within the sensing area. Position the sensor where sediment or oil will not accumulate within the sensing area.

In-Line Sensor Mounting

In-line mounted sensors must be situated so that the tee is always full and the sensors are never subjected to a drop in water level resulting in dryness. Refer to Figure 3 for typical installation.

Tap off the discharge side of the recirculation pump to provide a minimum flow of 1 gallon per minute through

the flow switch manifold. The sample must flow into the bottom of the manifold in order to close the flow switch, and return to a point of lower pressure in order to ensure flow. Install an isolation valve on both sides of the manifold to stop flow for sensor maintenance.

IMPORTANT: To avoid cracking the female pipe threads on the supplied plumbing parts, use no more than 3 wraps of Teflon tape and thread in the pipe FINGER tight plus 1/2 turn! Do not use pipe dope to seal the threads of the flow switch because the clear plastic will crack!

Submersion Sensor Mounting

If the sensors are to be submersed in the process, mount them firmly to the tank, and protect the cable with plastic pipe, sealed at the top with a cable gland, to prevent premature failure. Place the sensors in an area of good solution movement.

Sensors should be located such that they respond rapidly to a well-mixed sample of the process water and the treatment chemicals. If they are too close to the chemical injection point, they will see spikes in concentration and cycle on and off too frequently. If they are too far away from the chemical injection point, they will respond too slowly to the concentration changes, and you will overshoot the set point.

The **contacting conductivity sensor** should be placed as close to the controller as possible, to a maximum distance of 250 ft. (76 m). Less than 25 ft. (8 m) is recommended. The cable must be shielded from background electrical noise. Always route low voltage (sensor) signals with at least a 6" (15 cm) separation from AC voltage wiring.

The **electrodeless conductivity sensor** should be placed as close to the controller as possible, to a maximum distance of 120 ft. (37 m). Less than 20 ft. (6 m) is recommended. The cable must be shielded from background electrical noise. Always route low voltage (sensor) signals with at least a 6" (15 cm) separation from AC voltage wiring. These sensors are affected by the geometry and conductivity of their surroundings, so either maintain 6 inches (15 cm) of sample around the sensor or ensure that any nearby conductive or non-conductive items are consistently positioned. Do not install the sensor in the path of any electrical current that may be flowing in the solution, as this will shift the conductivity reading.

The **pH/ORP/ISE electrode** should be placed as close to the controller as possible, to a maximum distance of 1000 feet (305 m) from the controller. A junction box and shielded cable are available to extend the standard 20 foot (6 m) length. pH and ORP electrodes must be installed such that the measuring surfaces will always remain wet. A U-trap provided in the manifold design should achieve this, even if the sample flow stops. These electrodes also must be installed with the measuring surfaces pointing down; that is 5 degrees above the horizontal, at a minimum. The flow velocity past the sensor must be less than 10 ft./sec. (3 m/sec.)

The **disinfection sensor** should be placed as close to the controller as possible, to a maximum distance of 100 feet (30 m) from the controller. A junction box and shielded cable are available to extend the standard 20 foot (6 m) length. The sensor should be mounted such that the measuring surfaces will always stay wet. If the membrane dries out, it will respond slowly to changing disinfectant values for 24 hours, and if dried out repeatedly, will fail prematurely. The flow cell should be placed on the discharge side of a circulation pump or downhill from a gravity feed. Flow into the cell must come from the bottom side that has the 3/4" x 1/4" NPT reducing bushing installed. The reducing bushing provides the flow velocity required for accurate readings and must not be removed! A "U" trap should be installed so that if the flow stops, the sensor is still immersed in the water. The outlet of the flow cell must be plumbed to open atmosphere unless the system pressure is at or below 1 atmosphere. If the flow through the line cannot be stopped to allow for cleaning and calibration of the sensor, then it should be placed in a by-pass line with isolation valves to allow for sensor removal. Install the sensor vertically, with the measuring surface pointing down, at least 5 degrees above horizontal. Flow rate regulation must be done upstream from the sensor, because any flow restriction downstream can increase the pressure above atmospheric and damage the membrane cap!

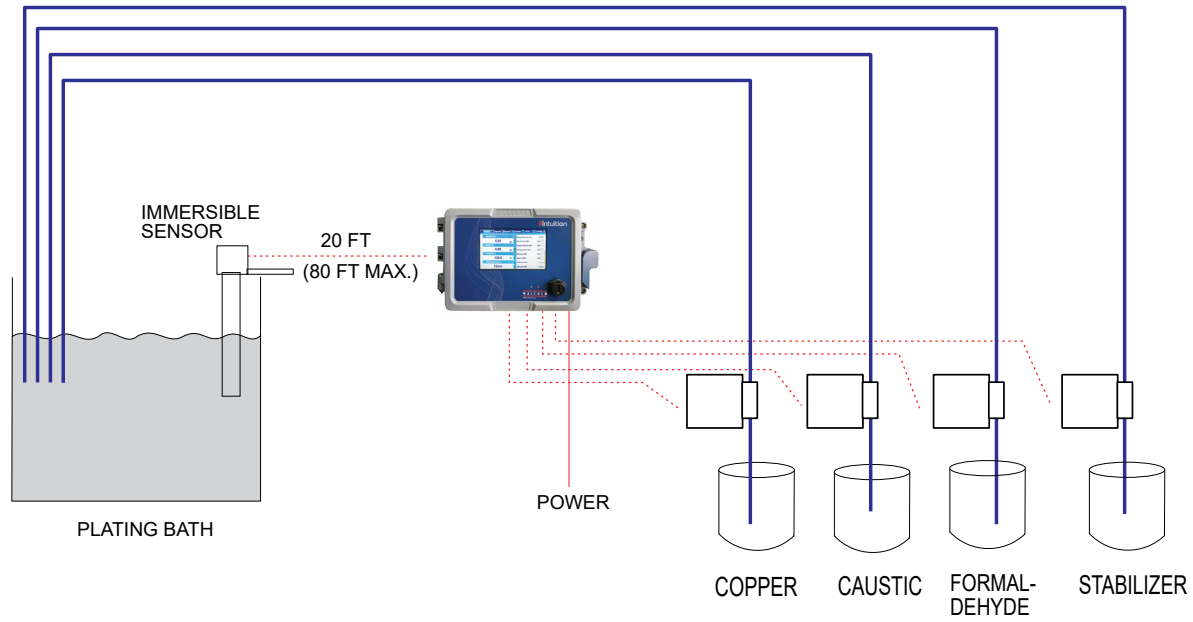

**WCU WITH IMMERSIBLE SENSOR
(TYPICAL ELECTROLESS COPPER APPLICATION)**

CONVEYORIZED SPRAY EQUIPMENT

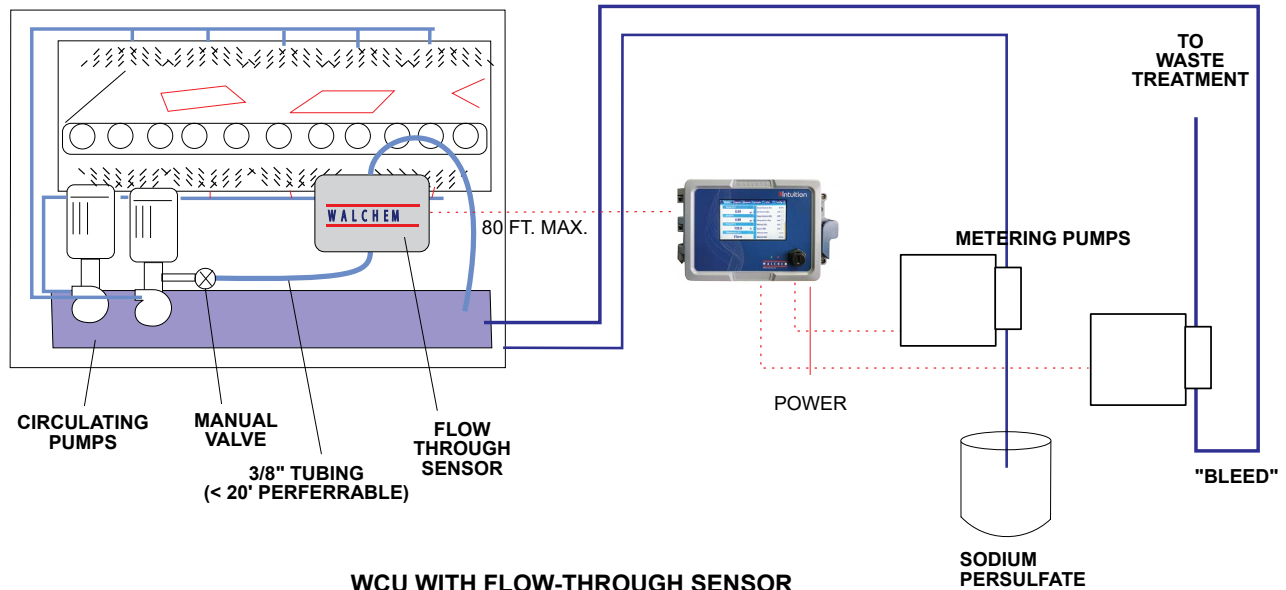

**WCU WITH FLOW-THROUGH SENSOR
(TYPICAL MICROETCH APPLICATION)**

Figure 1

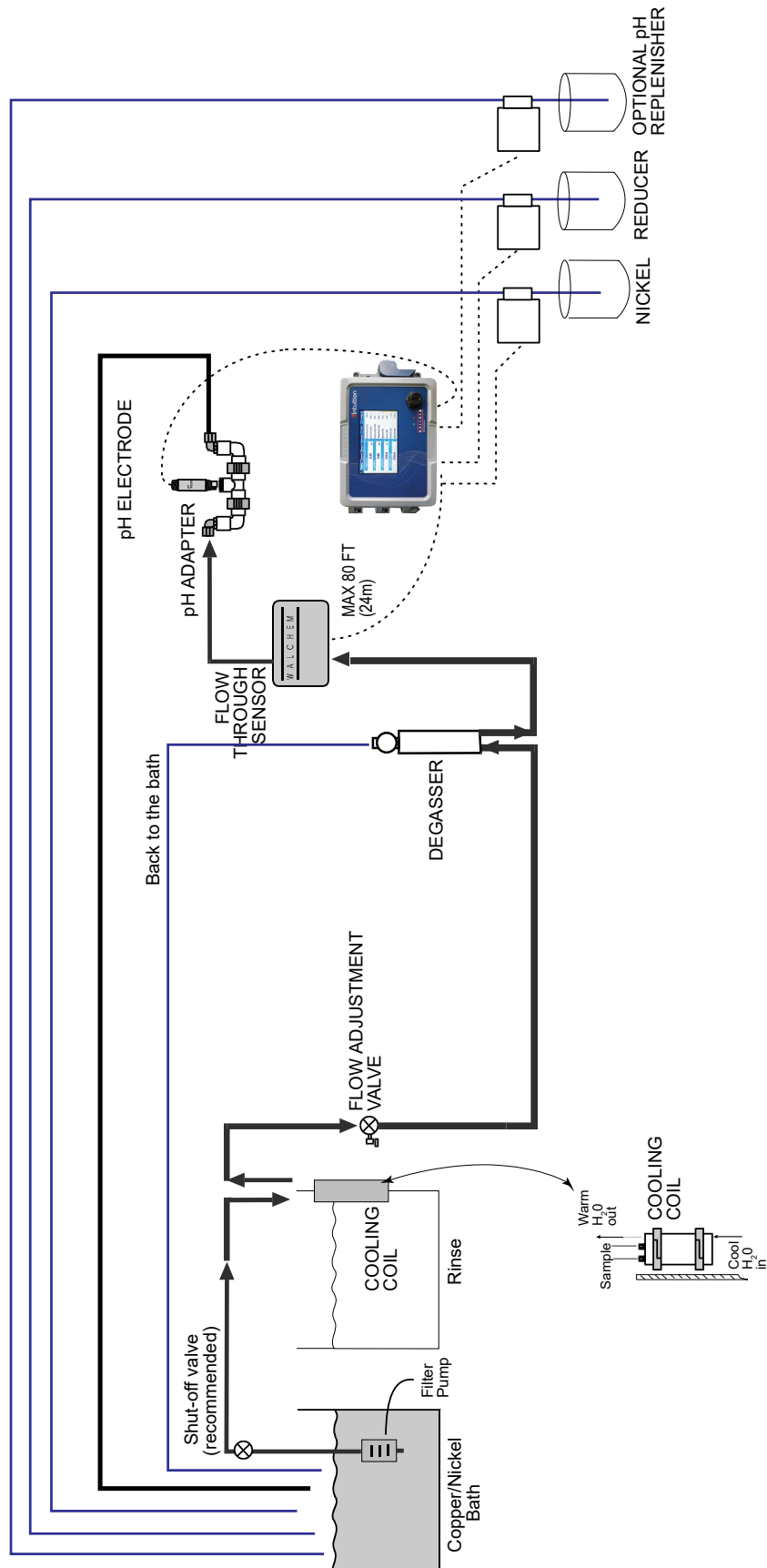

Figure 2
WNI with Flow through Sensor and Degasser
(Typical Electroless Nickel Application)

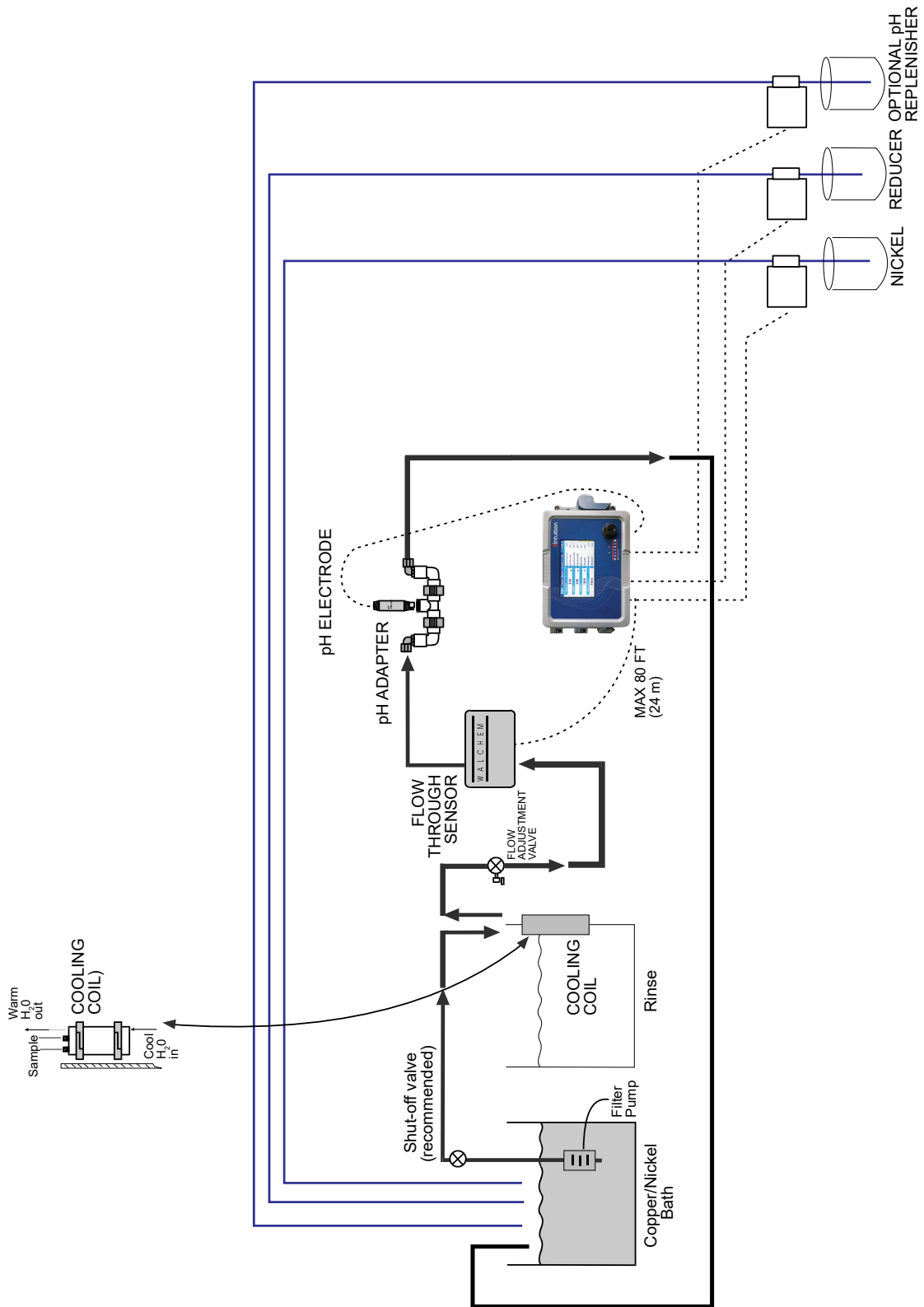





Figure 3
WNI with Flow Through Sensor, without Degasser
(Typical Electroless Nickel Application)

3.7 Icon Definitions

Symbol	Publication	Description
	IEC 417, No.5019	Protective Conductor Terminal
	IEC 417, No. 5007	On (Supply)
○	IEC 417, No. 5008	Off (Supply)
	ISO 3864, No. B.3.6	Caution, risk of electric shock
	ISO 3864, No. B.3.1	Caution

3.8 Electrical installation

The various standard wiring options are shown in figure 1, below. Your controller will arrive from the factory pre-wired or ready for hardwiring. Depending on your configuration of controller options, you may be required to hard-wire some or all of the input/output devices. Refer to figures 6 through 18 for circuit board layout and wiring.

Note: when wiring the optional flow meter contactor input, the 4-20 mA outputs or a remote flow switch, it is advisable to use stranded, twisted, shielded pair wire between 22-26 AWG. Shield should be terminated at the controller at the most convenient shield terminal.



CAUTION



1.	There are live circuits inside the controller even when the power switch on the front panel is in the OFF position! The front panel must never be opened before power to the controller is REMOVED! If your controller is prewired, it is supplied with an 8 foot, 18 AWG power cord with USA style plug. A tool (#1 Phillips driver) is required to open the front panel.
2.	When mounting the controller, make sure there is clear access to the disconnecting device!
3.	The electrical installation of the controller must be done by trained personnel only and conform to all applicable National, State and Local codes!
4.	Proper grounding of this product is required. Any attempt to bypass the grounding will compromise the safety of persons and property.
5.	Operating this product in a manner not specified by Walchem may impair the protection provided by the equipment.

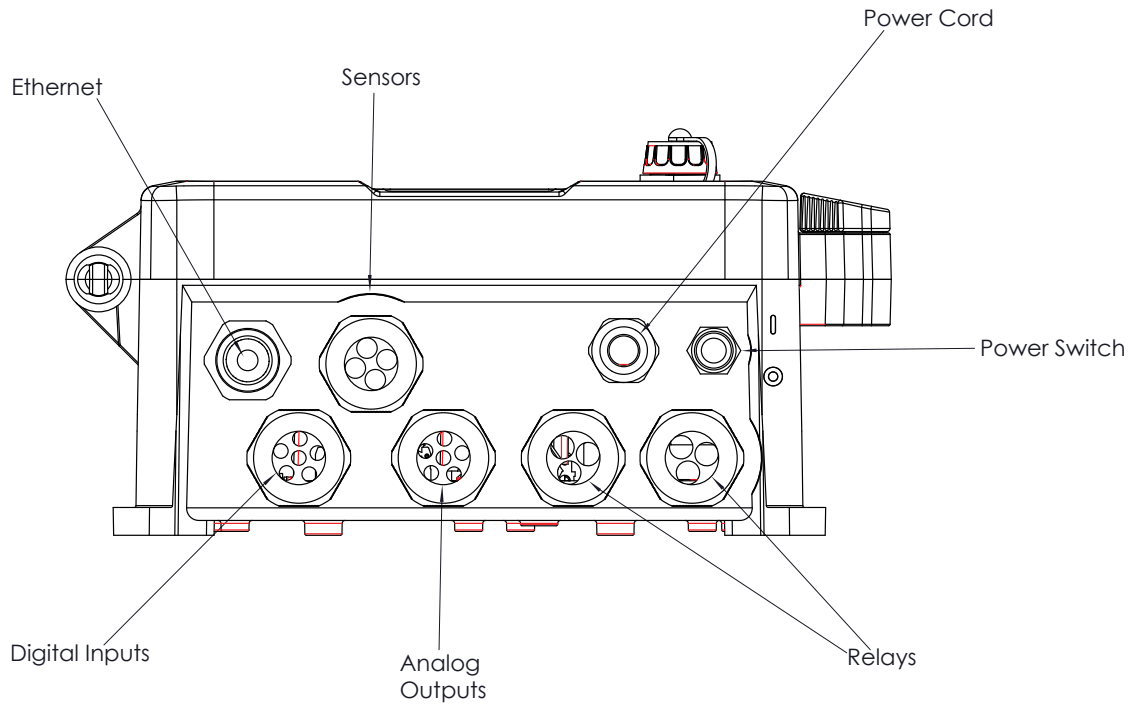

Figure 4 Conduit Wiring

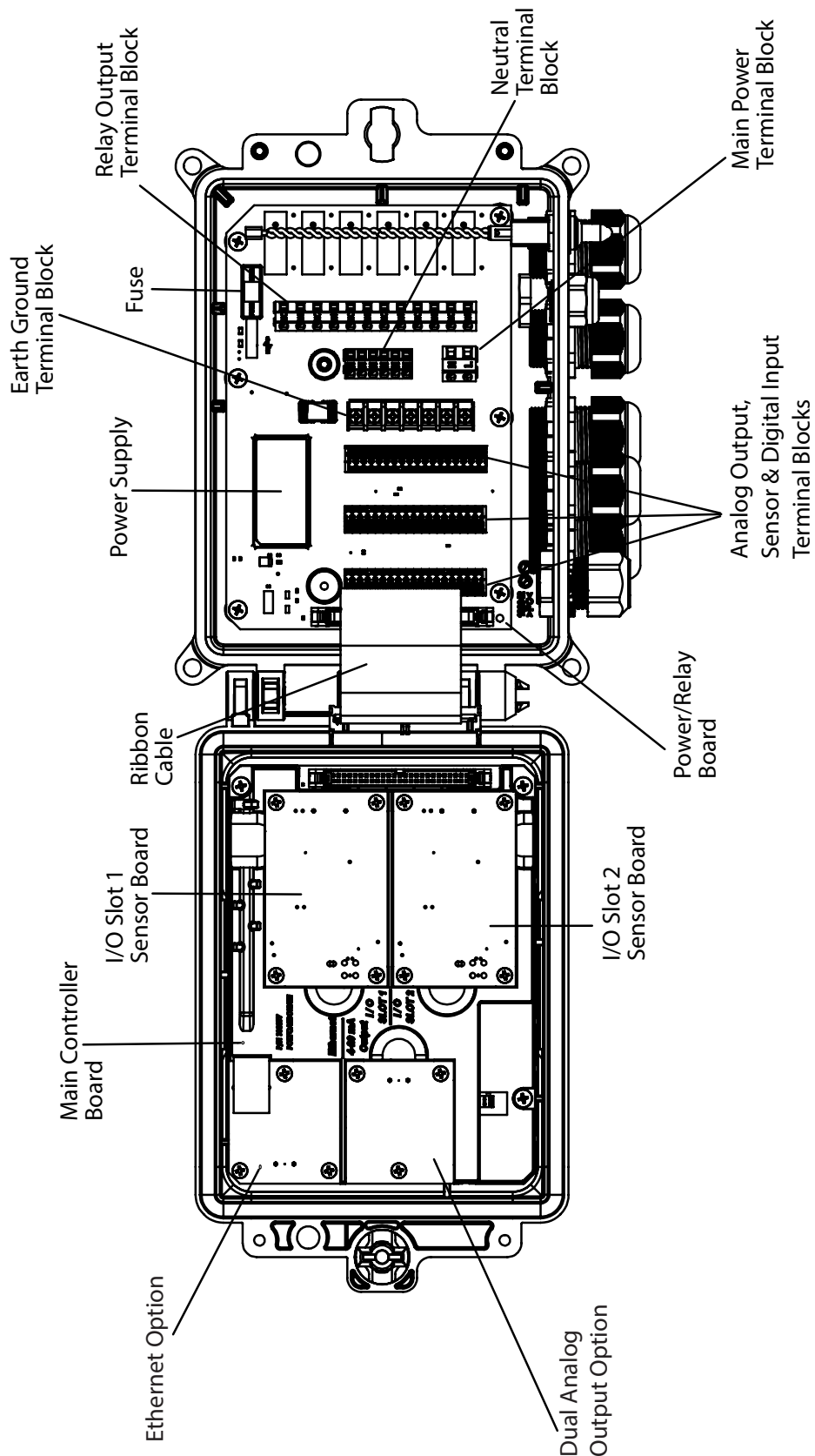
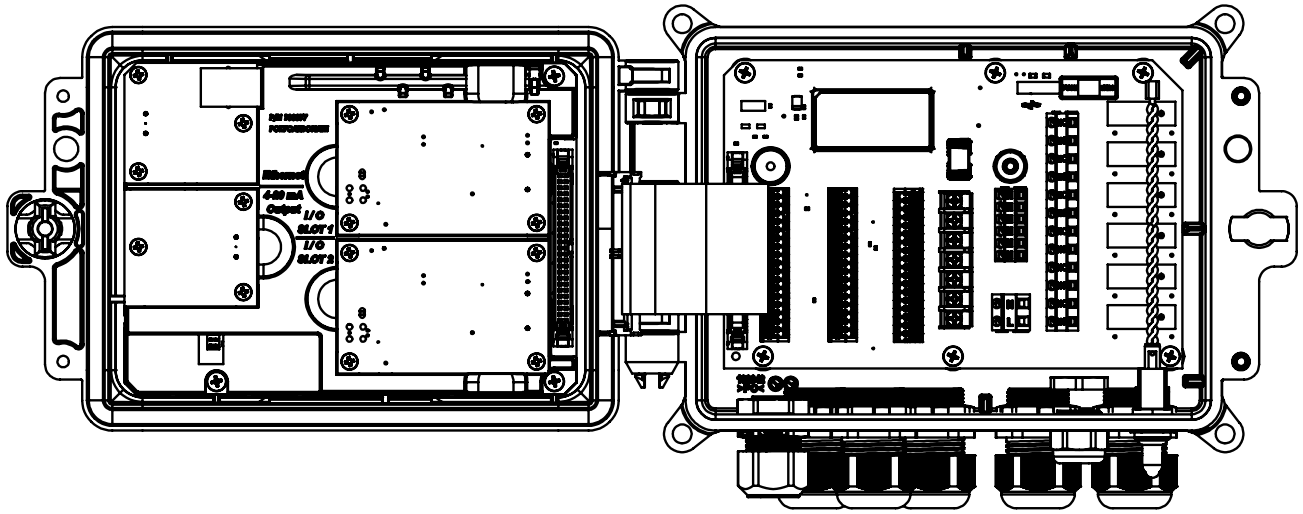
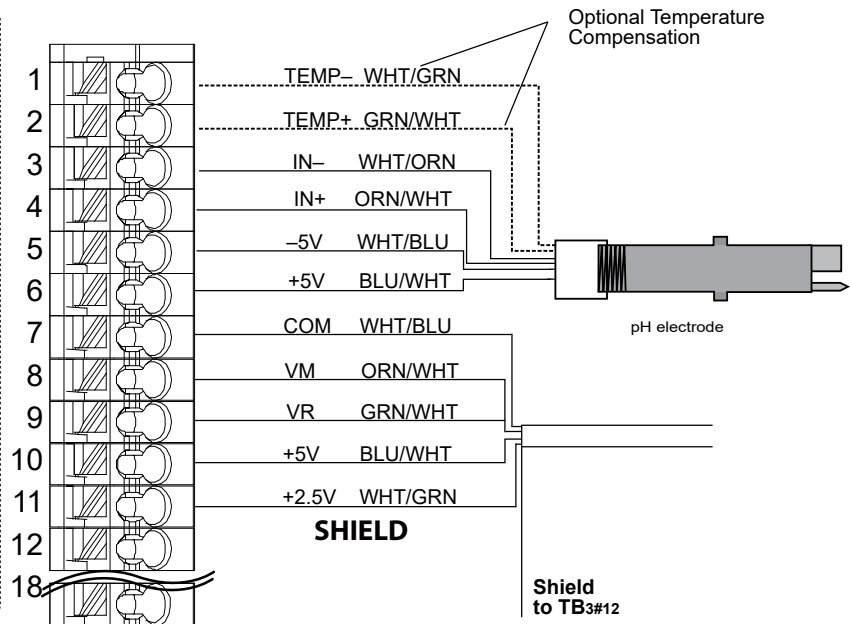

Figure 5 Parts Identification



	pH	Cu/Ni
1	TEMP-	
2	TEMP+	
3	IN-	
4	IN+	
5	-5V	
6	+5V	
7		COM
8		VM
9		VR
10		+5V
11		+2.5V
12	SHIELD	

Cu/Ni SHIELD USE TB3 #12



TB1 (for Sensor 1) or
 TB2 (for optional Sensor 2)

Figure 6 Copper/Nickel + pH Board Sensor Input Wiring

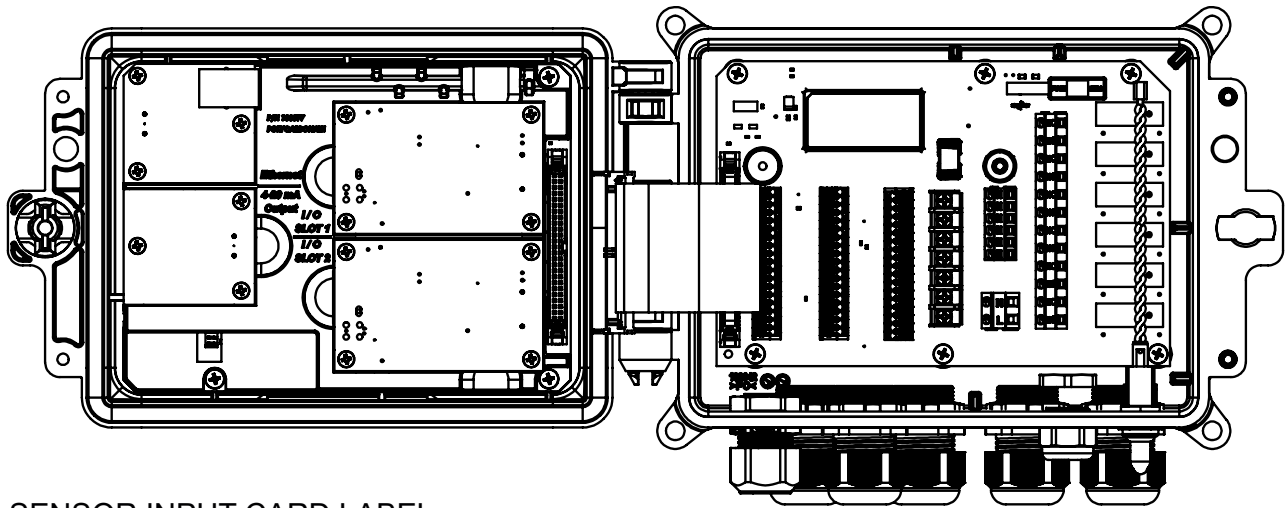

SENSOR INPUT CARD LABEL

	ECOND	CCOND	pH/ORP DIS
1	TEMP-	TEMP-	TEMP-
2	TEMP+	TEMP+	TEMP+
3	R-SHLD		IN-
4		RCV	IN+
5	RCV-		
6	RCV+		
7	X-SHLD	SHIELD	SHIELD
8			+5V
9			-5V
10	XMT+	XMT	
11	XMT-		
12			

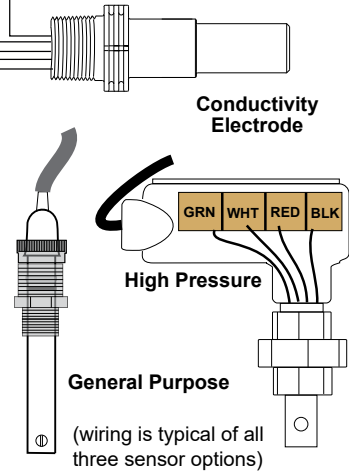
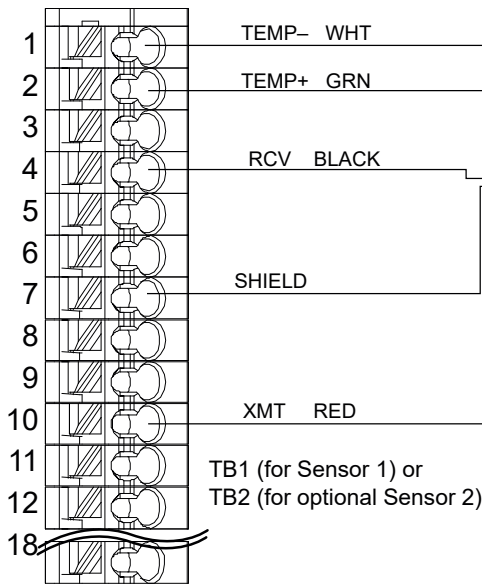

	CCOND	pH/ORP DIS	2 Wire Loop	2 Wire Pwrd	3 Wire	4 Wire
1	TEMP-	TEMP-				
2	TEMP+	TEMP+				
3	SHIELD	IN-				
4	RCV	IN+				
5		-5V				
6	XMT					
7		+5V				
8					COM(-)	24V(-)
9			+24V		+24V	+24V
10				XMTR-		XMTR-
11				XMTR-	XMTR+	XMTR+
12			SHIELD or use DI SHIELD (TB3 7-12)			

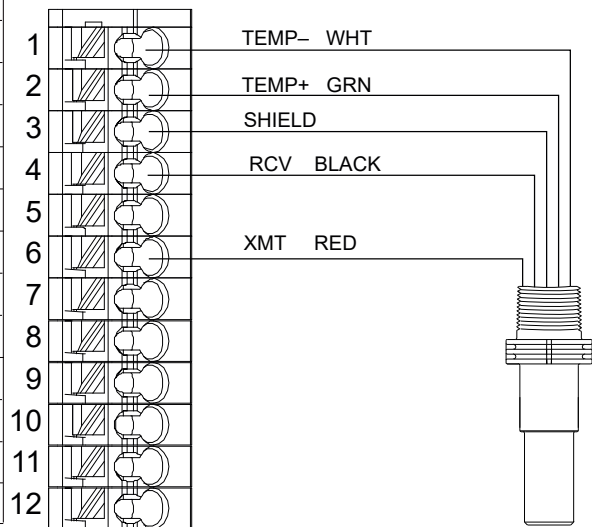

COMBINATION SENSOR/ANALOG CARD LABEL

TB1 (for Sensor 1) or TB2 (for optional Sensor 2)

Conductivity Electrode

Figure 7 Contacting Conductivity Sensor Input Wiring

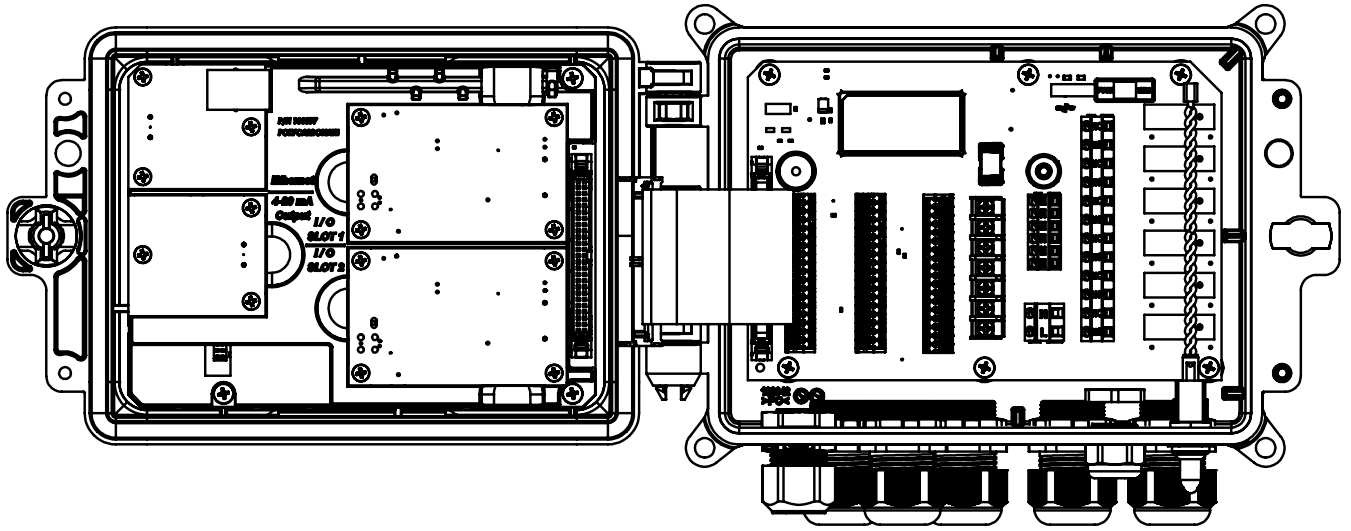

	ECOND	CCOND	pH/ORP DIS
1	TEMP-	TEMP-	TEMP-
2	TEMP+	TEMP+	TEMP+
3	R-SHLD		IN-
4		RCV	IN+
5	RCV-		
6	RCV+		
7	X-SHLD	SHIELD	SHIELD
8			+5V
9			-5V
10	XMT+	XMT	
11	XMT-		
12	⏏		

SENSOR LABEL

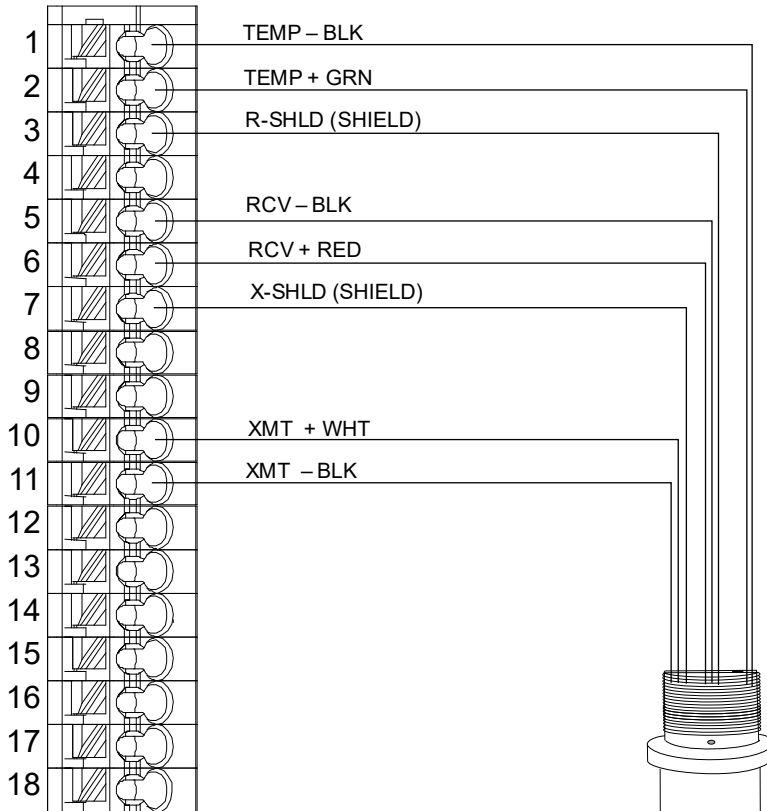

TB1 (for Sensor 1) or
TB2 (for optional Sensor 2)

ELECTRODELESS
CONDUCTIVITY
SENSOR

Figure 8 Electrodeless Conductivity Sensor Input Wiring

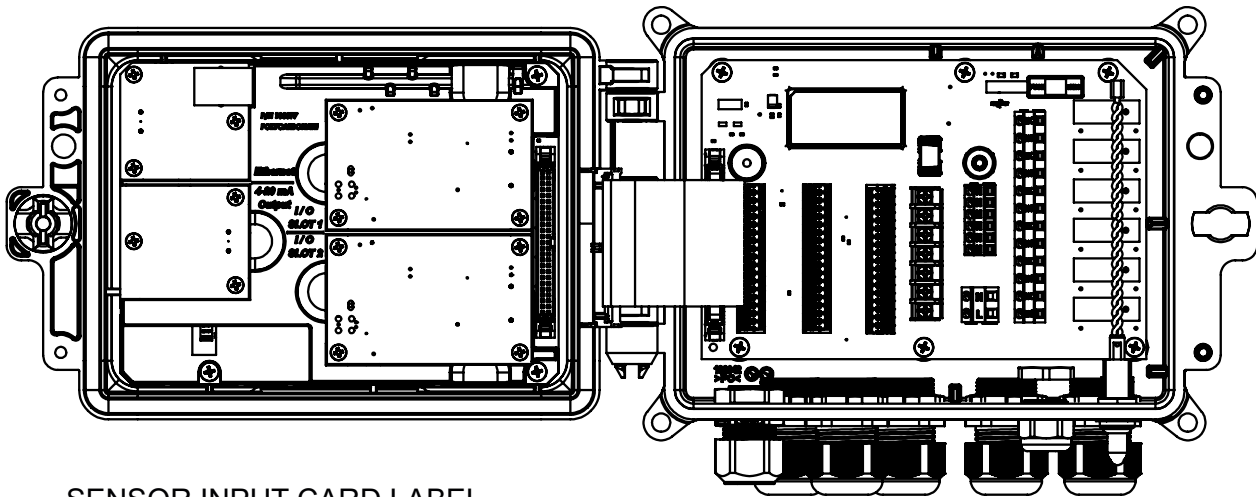

SENSOR INPUT CARD LABEL

	ECOND	CCOND	pH/ORP DIS
1	TEMP-	TEMP-	TEMP-
2	TEMP+	TEMP+	TEMP+
3	R-SHLD		IN-
4		RCV	IN+
5	RCV-		
6	RCV+		
7	X-SHLD	SHIELD	SHIELD
8			+5V
9			-5V
10	XMT+	XMT	
11	XMT-		
12			⏏

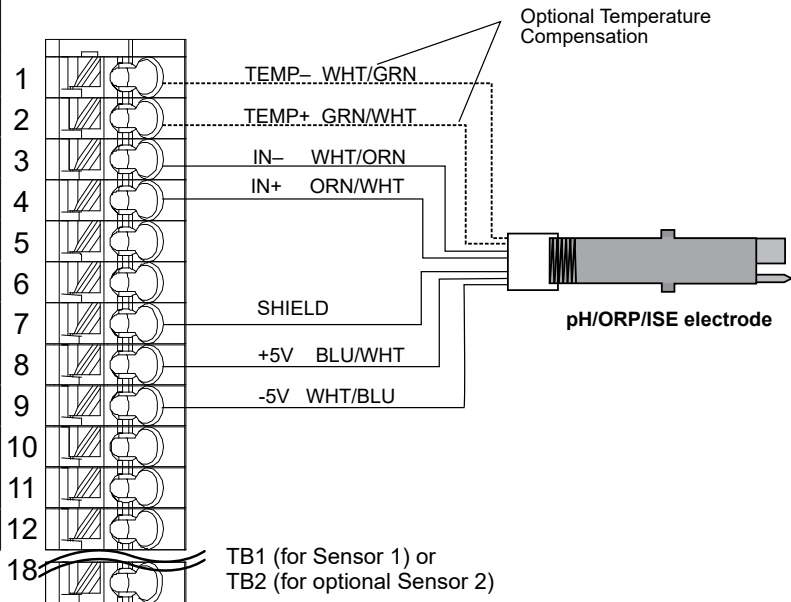

	CCOND	pH/ORP DIS	2 Wire Loop	2 Wire Pwrd	3 Wire	4 Wire
1	TEMP-	TEMP-				
2	TEMP+	TEMP+				
3	SHIELD	IN-				
4	RCV	IN+				
5		-5V				
6	XMT					
7		+5V				
8					COM(-)	24V(-)
9			+24V		+24V	+24V
10					XMTR-	XMTR-
11					XMTR- XMTR+	XMTR+ XMTR+
12			SHIELD or use DI SHIELD (TB3 7-12)			

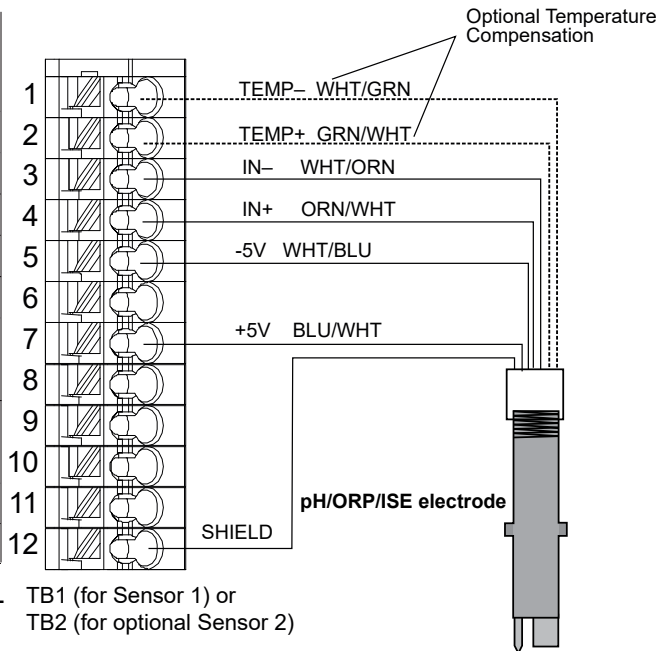

COMBINATION SENSOR/ANALOG CARD LABEL

Figure 9 pH/ORP/ISE Sensor Input Wiring

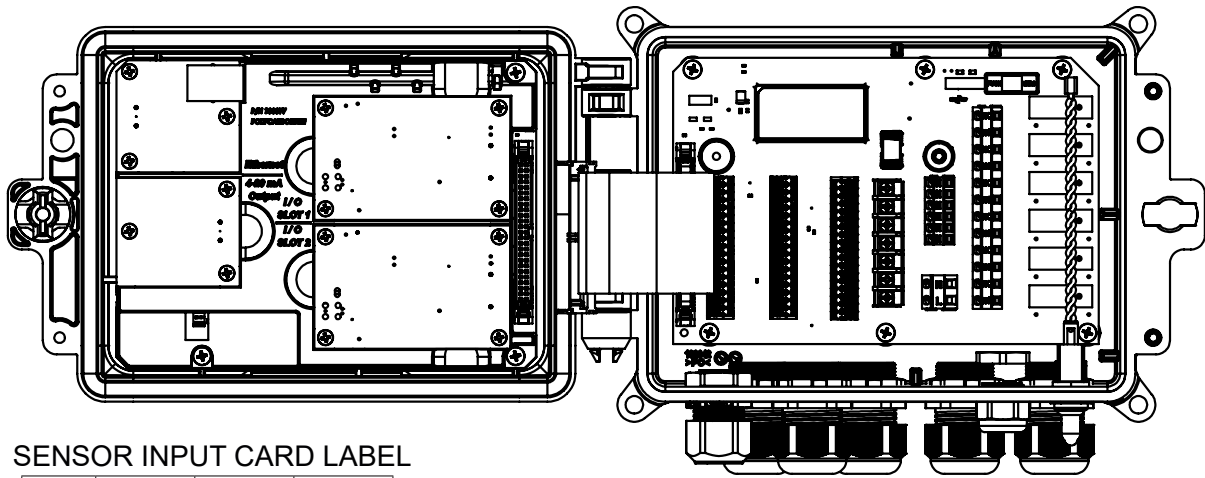

SENSOR INPUT CARD LABEL

	ECOND	CCOND	pH/ORP DIS
1	TEMP-	TEMP-	TEMP-
2	TEMP+	TEMP+	TEMP+
3	R-SHLD		IN-
4		RCV	IN+
5	RCV-		
6	RCV+		
7	X-SHLD	SHIELD	SHIELD
8			+5V
9			-5V
10	XMT+	XMT	
11	XMT-		
12			

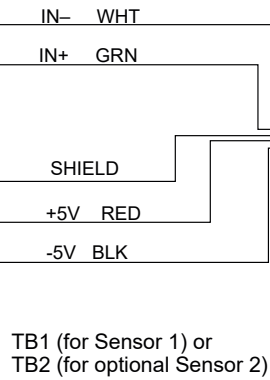
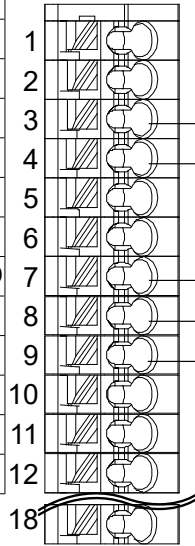

TB1 (for Sensor 1) or
TB2 (for optional Sensor 2)

	CCOND	pH/ORP DIS	2 Wire Loop	2 Wire Pwrd	3 Wire	4 Wire
1	TEMP-	TEMP-				
2	TEMP+	TEMP+				
3	SHIELD	IN-				
4	RCV	IN+				
5		-5V				
6	XMT					
7		+5V				
8					COM(-) 24V(-)	
9			+24V		+24V	+24V
10					XMTR-	XMTR-
11					XMTR-	XMTR+
12			SHIELD or use DI SHIELD (TB3 7-12)			

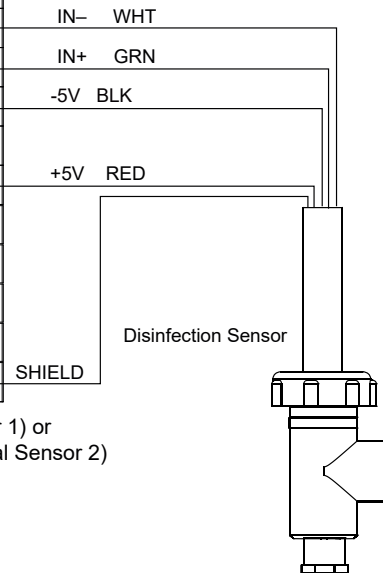
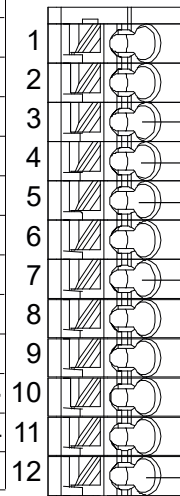

TB1 (for Sensor 1) or
TB2 (for optional Sensor 2)

COMBINATION SENSOR/ANALOG CARD LABEL

Figure 10 Disinfection Sensor Input Wiring

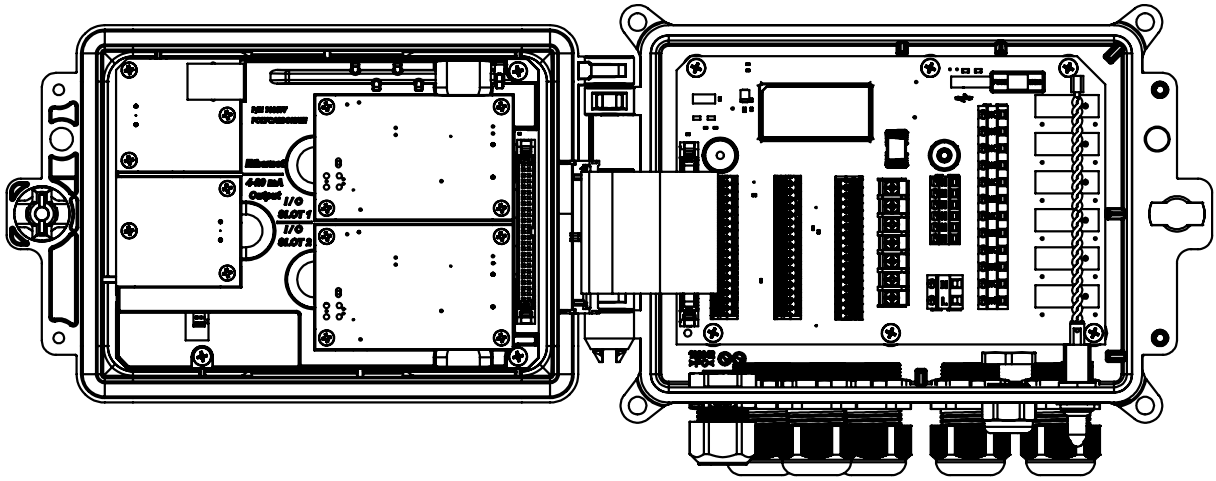

TB Pin#	Type of Transmitter				AI#
	2 Wire Loop	2 Wire Powered	3 Wire	4 Wire	
1	+24V		+24V	+24V	1
2	●		●	24V(-)	
3	●	XMTR-	●	XMTR-	
4	XMTR-	XMTR+	XMTR+	XMTR+	
5			COM(-)		
6	SHIELD	SHIELD	SHIELD	SHIELD	
7	+24V		+24V	+24V	2
8	●		●	24V(-)	
9	●	XMTR-	●	XMTR-	
10	XMTR-	XMTR+	XMTR+	XMTR+	
11			COM(-)		
12	SHIELD	SHIELD	SHIELD	SHIELD	

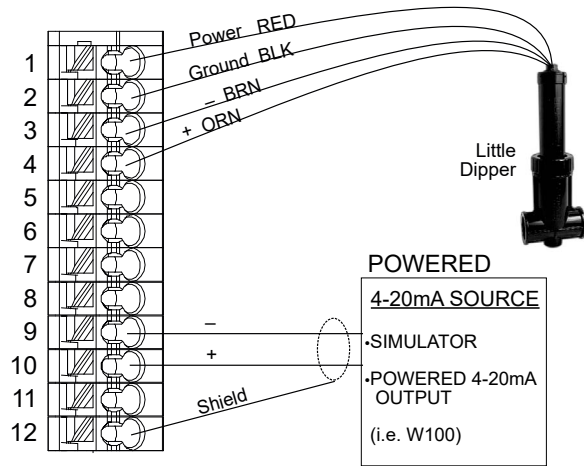

TB1 (for Sensor 1) or
TB2 (for optional Sensor 2)

TB Pin#	Type of Transmitter				AI#
	2 Wire Loop	2 Wire Powered	3 Wire	4 Wire	
1	+24V		+24V	+24V	1
2	●		●	24V(-)	
3	●	XMTR-	●	XMTR-	
4	XMTR-	XMTR+	XMTR+	XMTR+	
5			COM(-)		
6	SHIELD	SHIELD	SHIELD	SHIELD	
7	+24V		+24V	+24V	2
8	●		●	24V(-)	
9	●	XMTR-	●	XMTR-	
10	XMTR-	XMTR+	XMTR+	XMTR+	
11			COM(-)		
12	SHIELD	SHIELD	SHIELD	SHIELD	

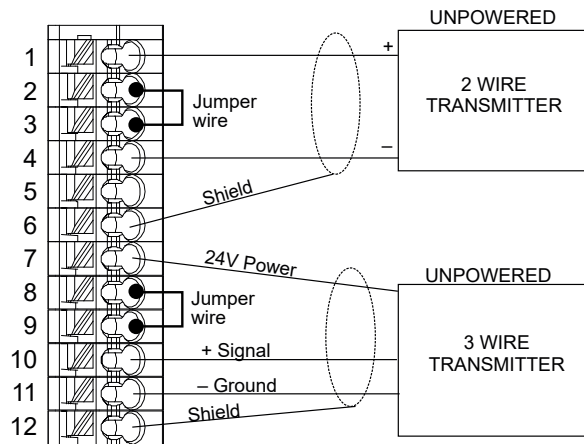

TB1 (for Sensor 1) or
TB2 (for optional Sensor 2)

Figure 11 Dual 4-20mA Sensor Input Wiring

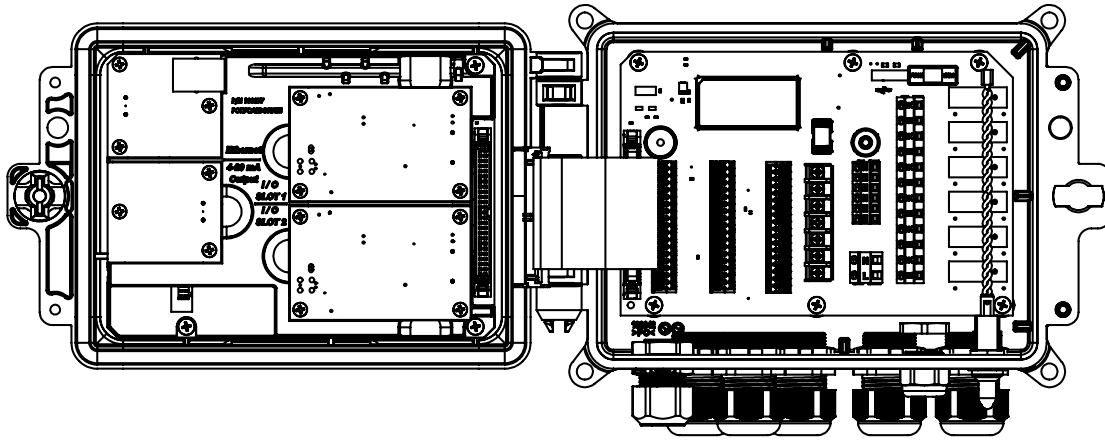

SENSOR LABEL

	CCOND	pH/ORP DIS	2 Wire Loop	2 Wire Pwrd	3 Wire	4 Wire
1	TEMP-	TEMP-				

TB1 (for Sensor 1) or TB2 (for optional Sensor 2)



8					COM(-)	24V(-)
9			+24V		+24V	+24V
10					XMTR-	XMTR-
11					XMTR-	XMTR+ XMTR+ XMTR+
12			SHIELD or use DI SHIELD (TB3 7-12)			

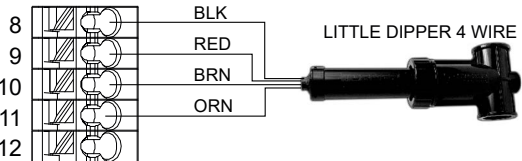

	CCOND	pH/ORP DIS	2 Wire Loop	2 Wire Pwrd	3 Wire	4 Wire
1	TEMP-	TEMP-				



8					COM(-)	24V(-)
9			+24V		+24V	+24V
10					XMTR-	XMTR-
11					XMTR-	XMTR+ XMTR+ XMTR+
12			SHIELD or use DI SHIELD (TB3 7-12)			

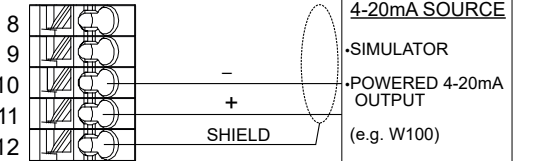

	CCOND	pH/ORP DIS	2 Wire Loop	2 Wire Pwrd	3 Wire	4 Wire
1	TEMP-	TEMP-				



8					COM(-)	24V(-)
9			+24V		+24V	+24V
10					XMTR-	XMTR-
11					XMTR-	XMTR+ XMTR+ XMTR+
12			SHIELD or use DI SHIELD (TB3 7-12)			

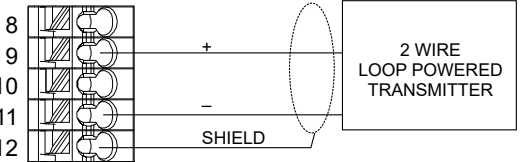

	CCOND	pH/ORP DIS	2 Wire Loop	2 Wire Pwrd	3 Wire	4 Wire
1	TEMP-	TEMP-				



8					COM(-)	24V(-)
9			+24V		+24V	+24V
10					XMTR-	XMTR-
11					XMTR-	XMTR+ XMTR+ XMTR+
12			SHIELD or use DI SHIELD (TB3 7-12)			

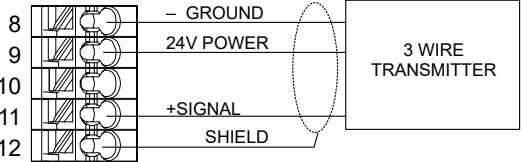

NOTE: To program the combination card analog input, you must go to Inputs menu, then enter the analog input (S13 or S23), scroll down to Transmitter, and select the type of transmitter from the list.

Figure 12 Combination Card 4-20mA Dual Sensor Input Wiring

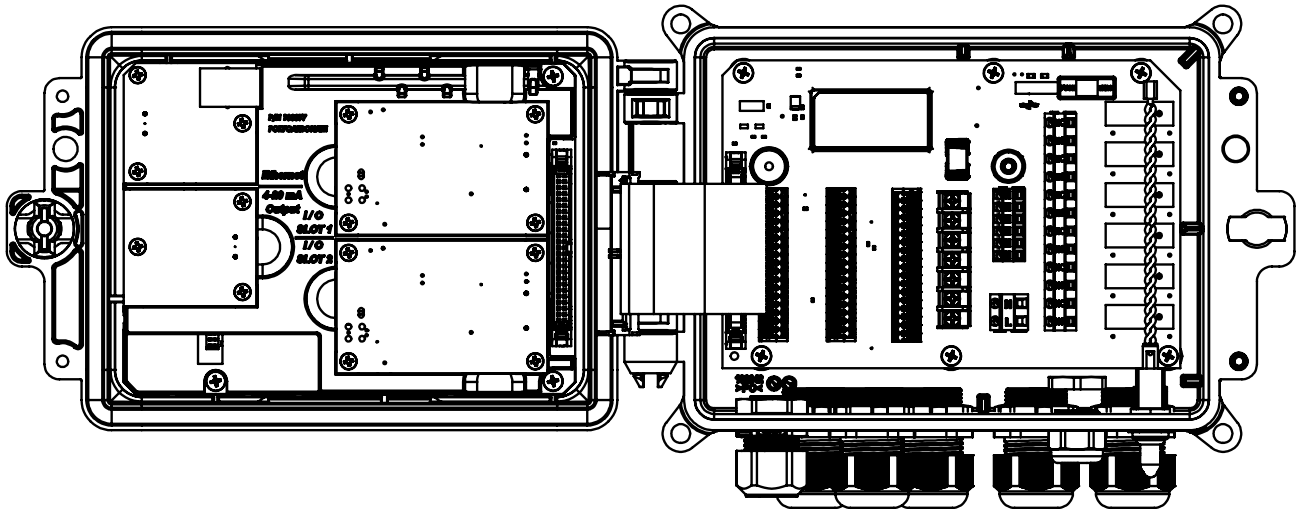

1		1 DIG IN 3+	1		
2		2 DIG IN 3-	2		
3		3 +9 VDC	3		
4		4 DIG IN 4+	4		
5		5 DIG IN 4-	5		
6	SEE SENSOR 1 LABEL	6 +9 VDC	6	SEE SENSOR 2 LABEL	
7		7	7		
8		8	8		
9		9 DI SHIELD	9		
10		10	10		
11		11	11		
12		12	12		
13	DIG IN 1+	13 DIG IN 5+	13	DIG IN 2+	
14	DIG IN 1-	14 DIG IN 5-	14	DIG IN 2-	
15	+9 VDC	15 +9 VDC	15	+9 VDC	
16	4-20 OUT1+	16 DIG IN 6+	16	4-20 OUT2+	
17	4-20 OUT1-	17 DIG IN 6-	17	4-20 OUT2-	
18	SHIELD	18 +9 VDC	18	SHIELD	
TB1		TB3		TB2	

SAFETY COVER LABEL

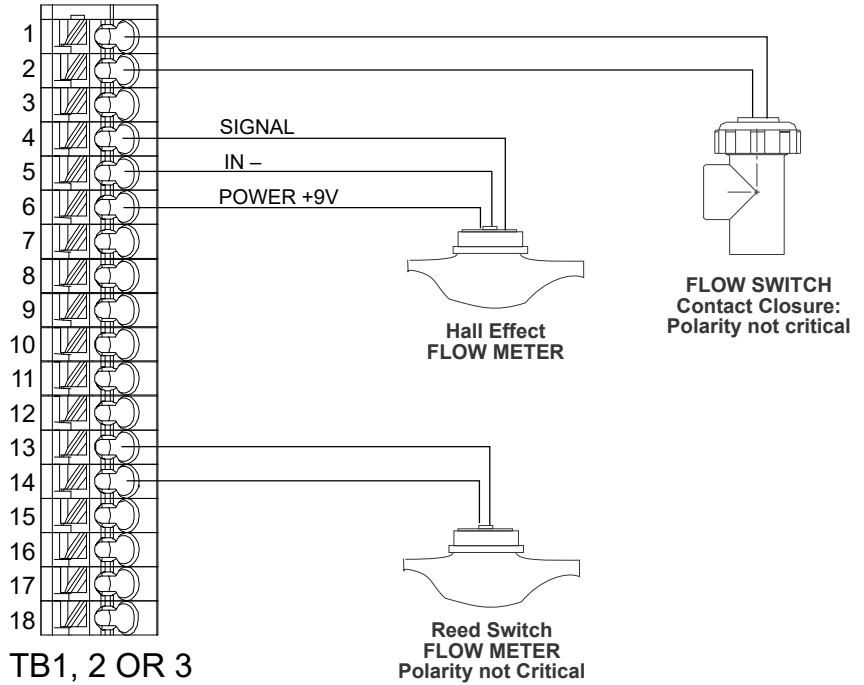

Figure 13 Digital Input Wiring

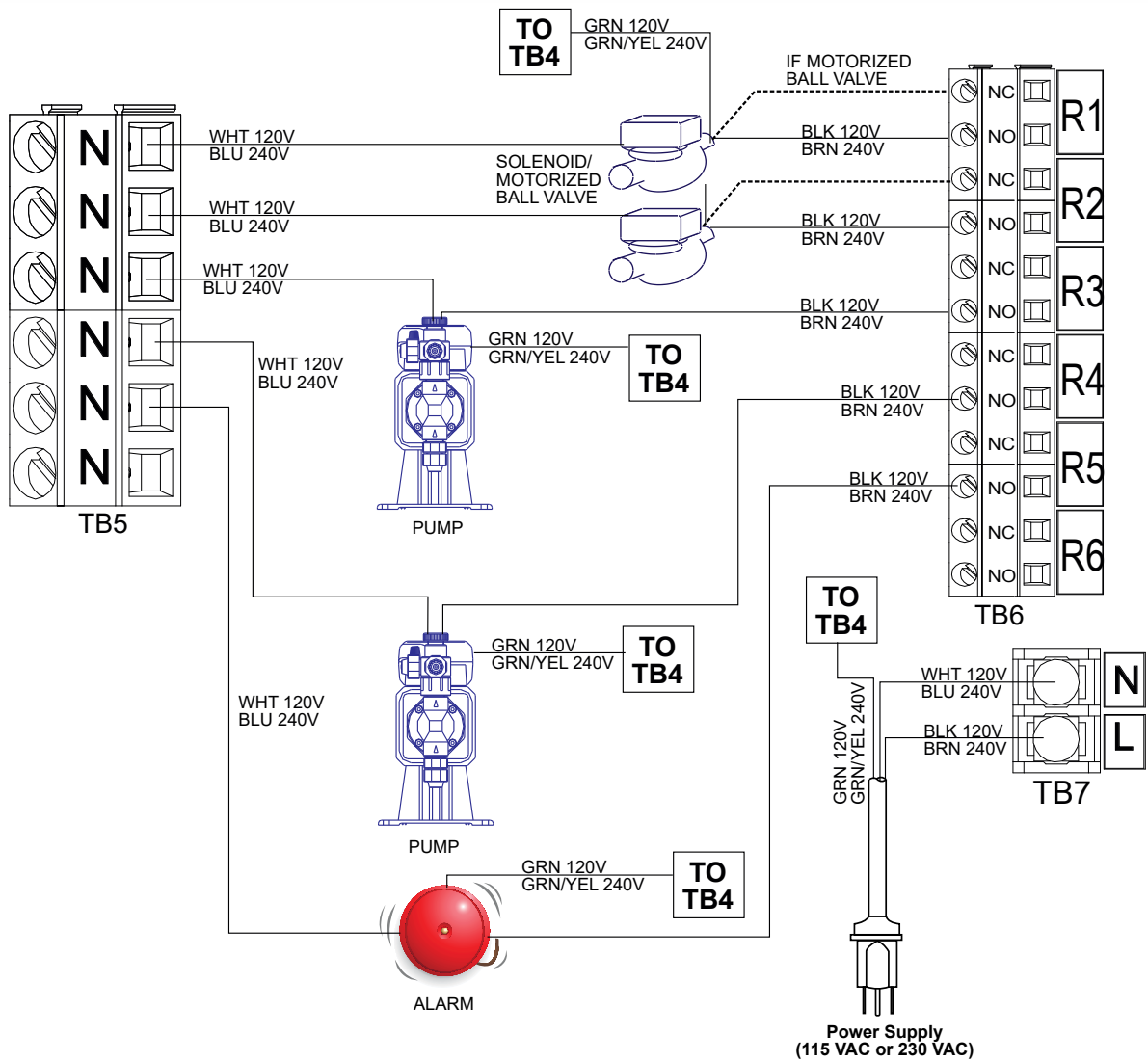
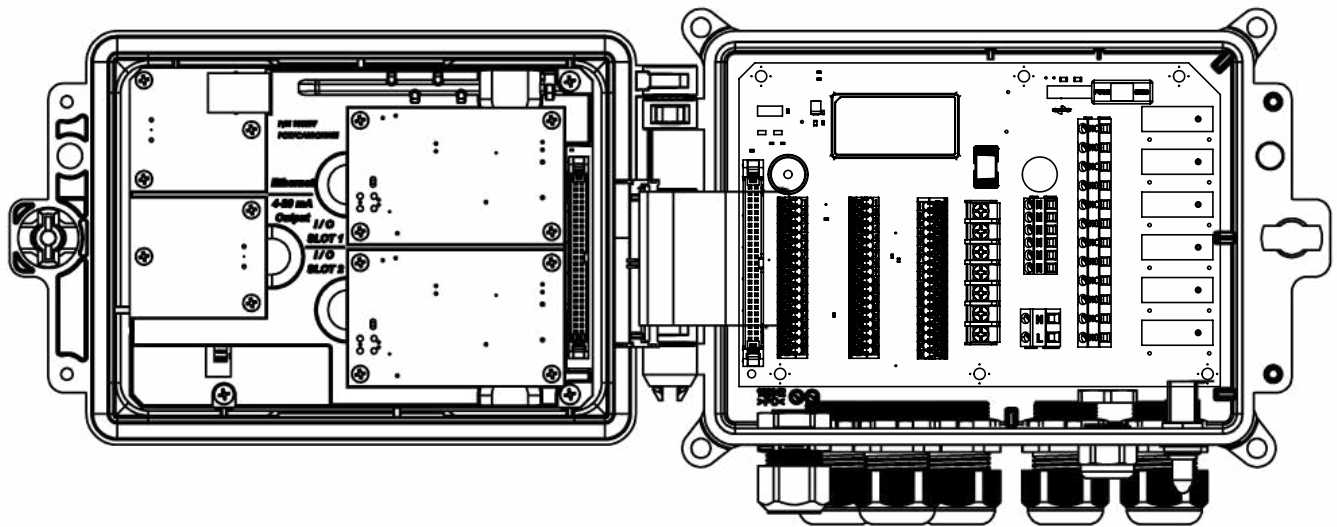

Figure 14 W600 AC Power & Relay Output Wiring

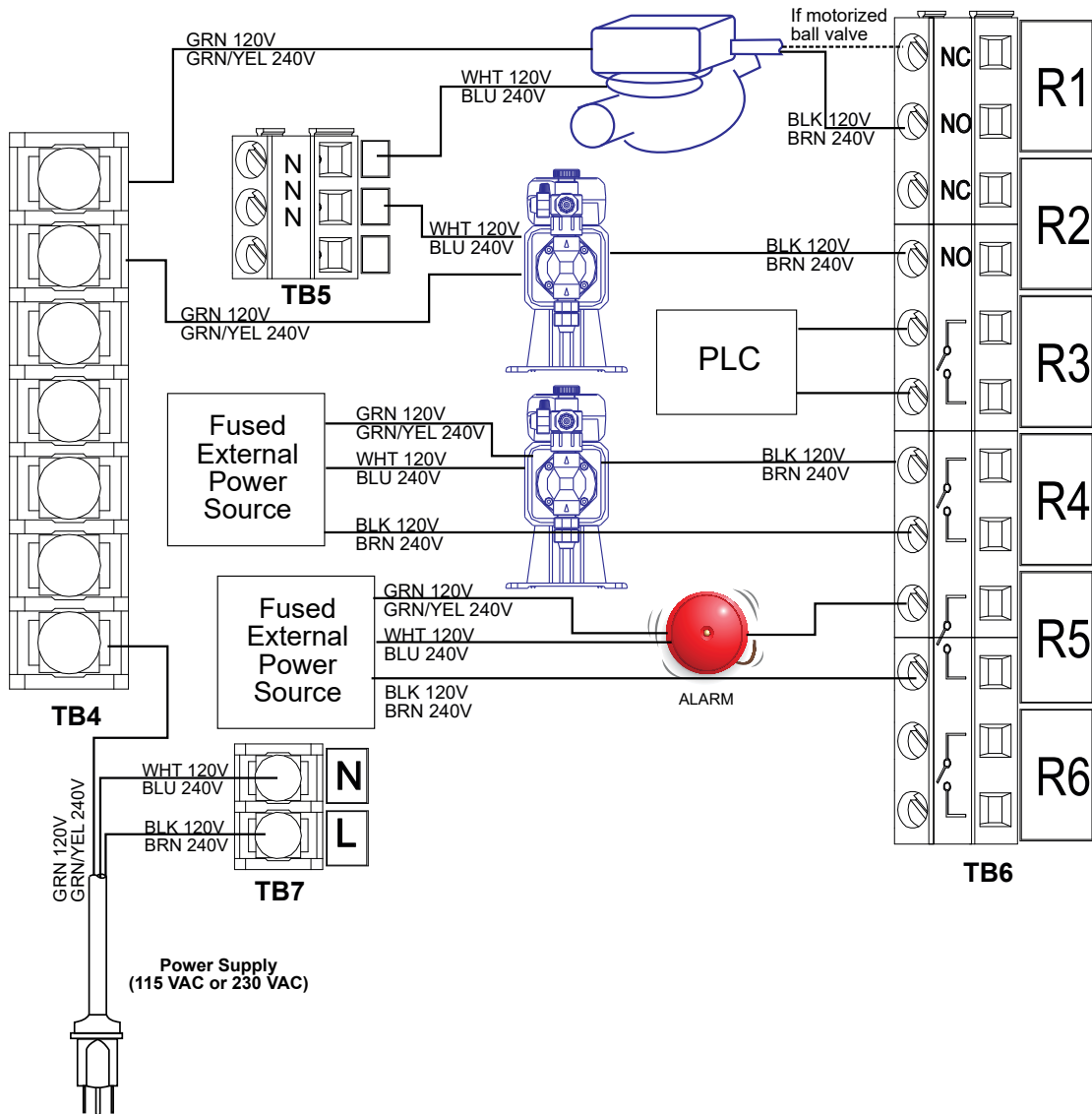
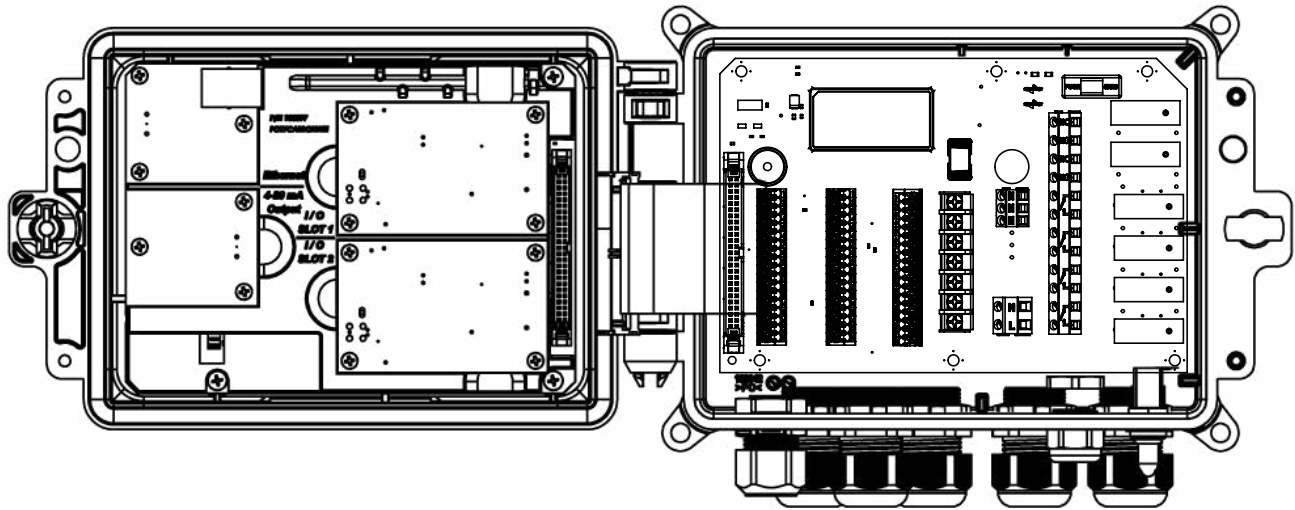

Figure 15 W610 AC Power & Relay Output Wiring

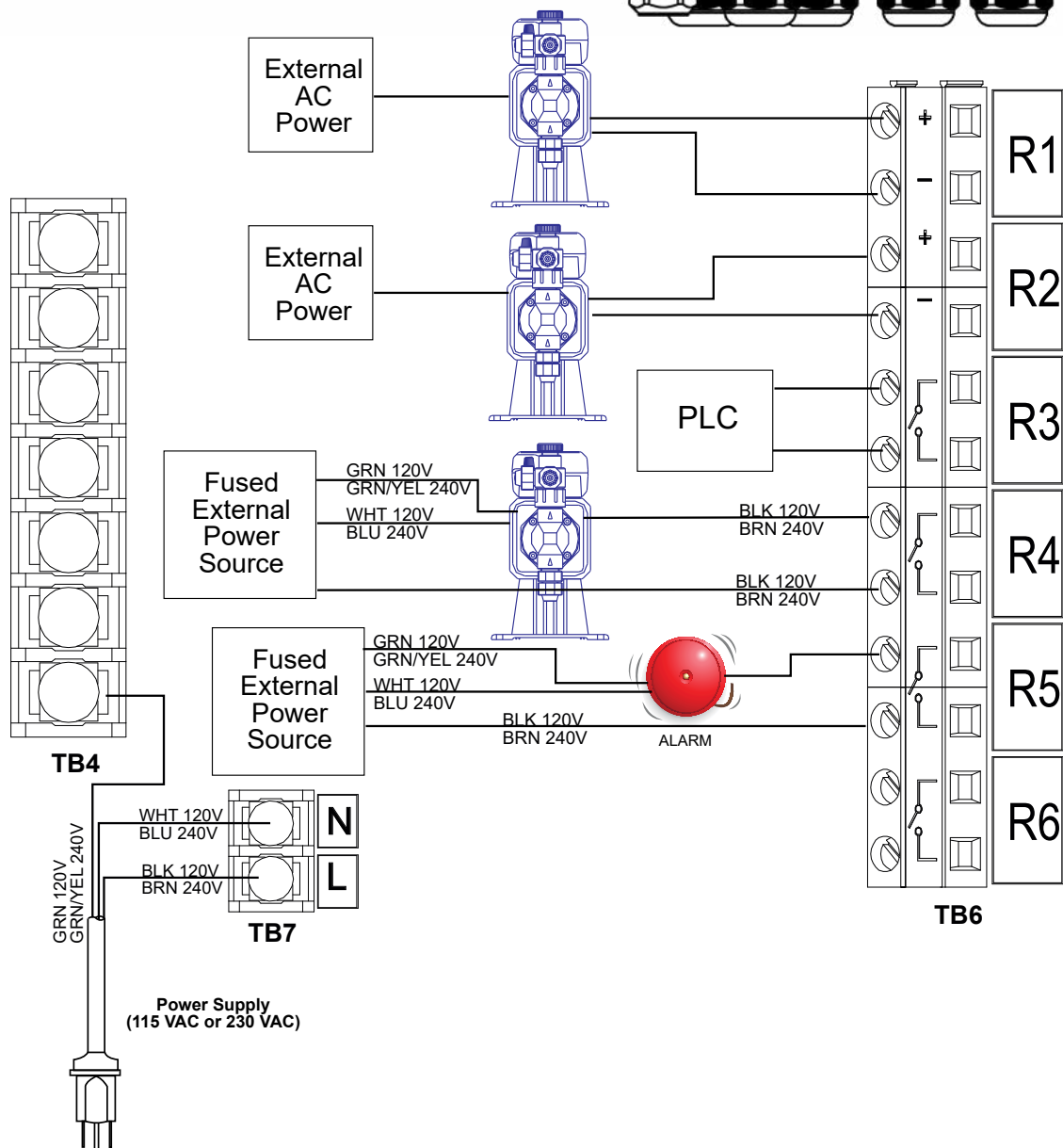
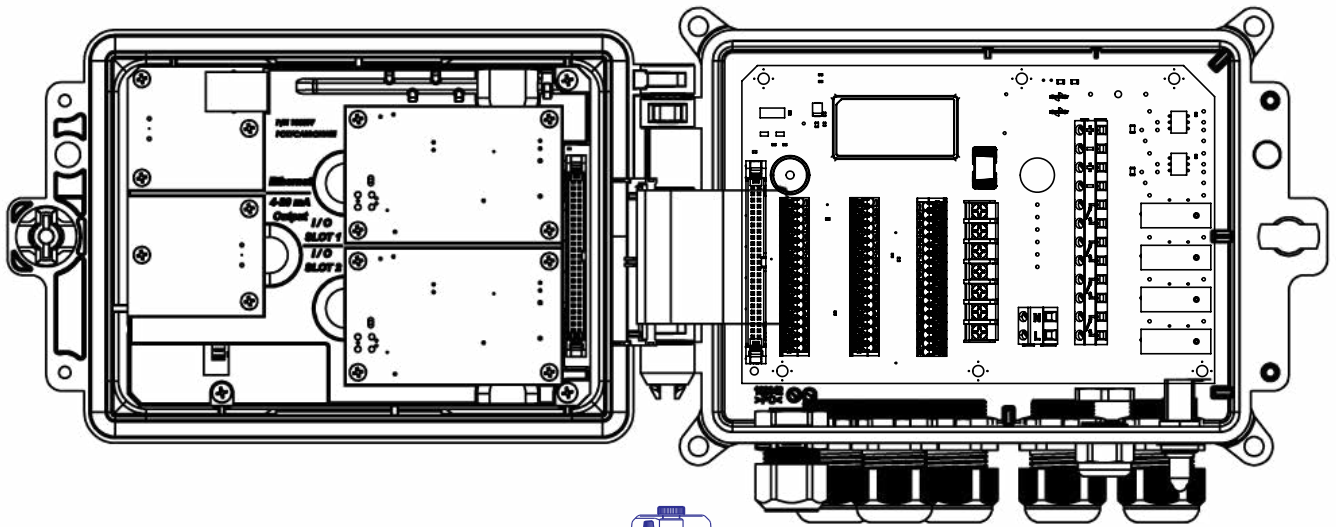

Figure 16 W620 AC Power & Relay Output Wiring

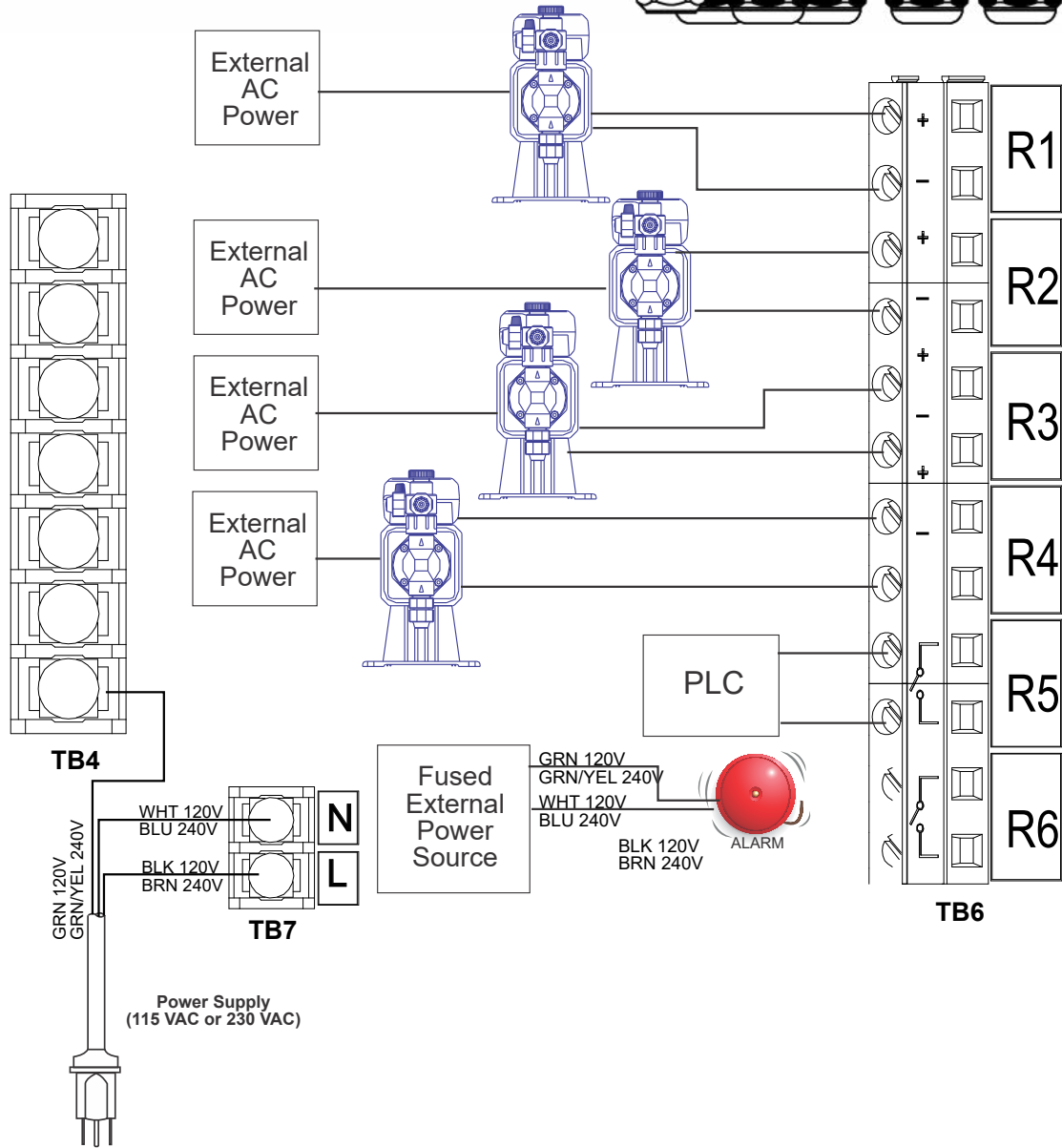
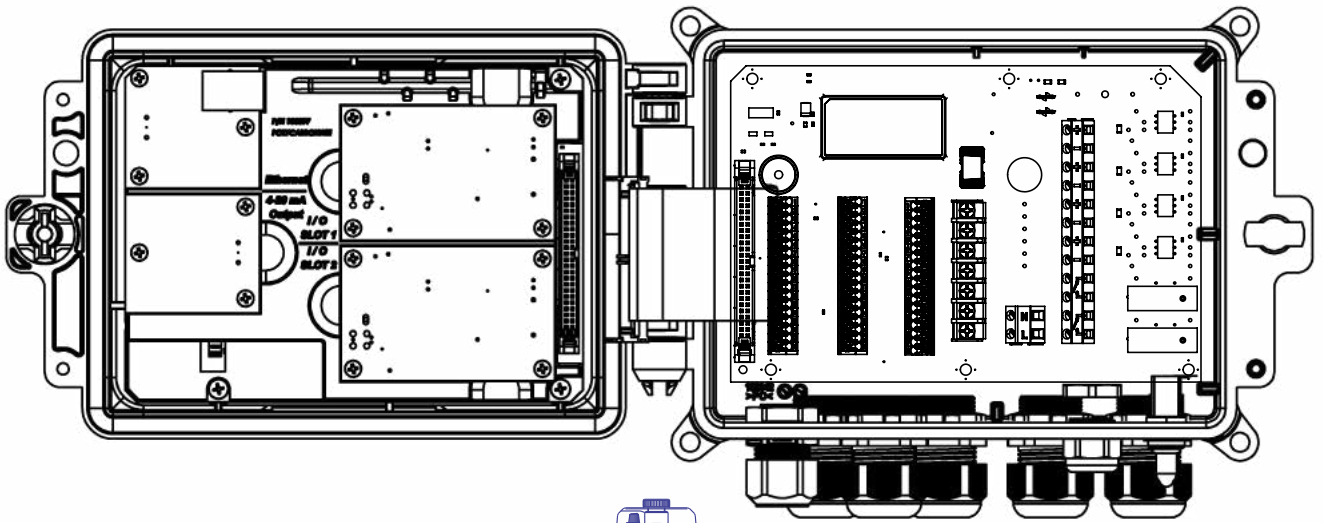

Figure 17 W640 AC Power & Relay Output Wiring

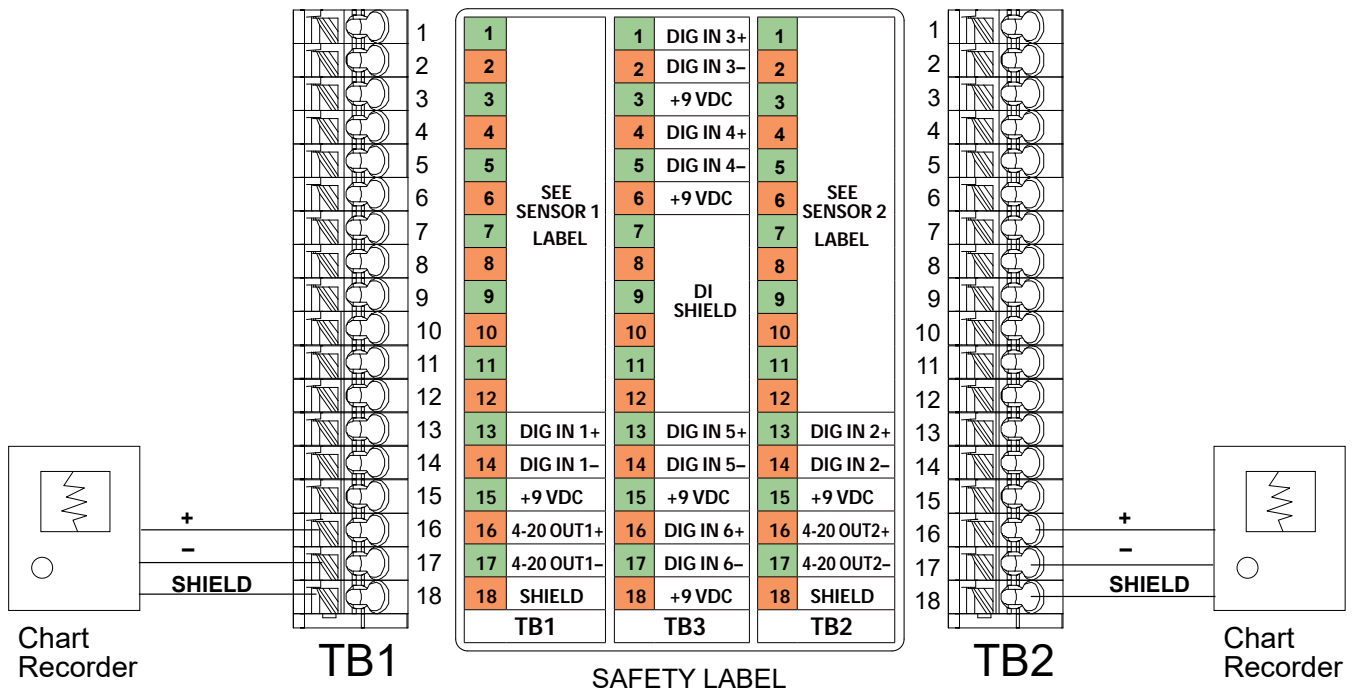
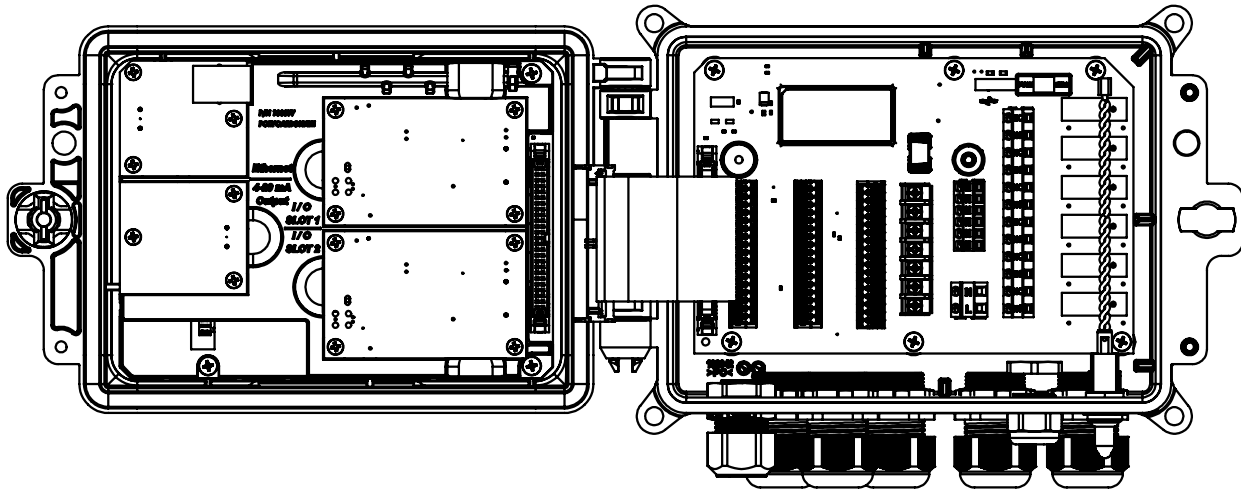

Figure 18 Analog Output Wiring

4.0 FUNCTION OVERVIEW

4.1 Front Panel



Figure 19 Front Panel

4.2 Touchscreen

A Home screen is displayed while the controller is on. Across the top of the screen are tabs for each major menu group: Home, Inputs, Outputs, Graphs, HOA (Hand – Off – Auto output operation), Configuration, and Alarms. Touching the tab brings up the menus associated with that group.

Below these tabs, this display shows user-defined fields containing input readings or status of outputs. Touching any of these fields on the Home Screen will bring up the item’s Details Screen, where you can access calibration and setting menus or graph that parameter. If more than one page of items is selected to be displayed on the Home screen, it will automatically scroll between them, or swiping up or down manually moves to the next page. A yellow bar on the right will indicate if multiple pages are available and where the current page is relative to the others.

4.3 Icons

The following icons appear on the Home screen. Touch the icon to get to the menu selections.



Alarm Menu



Inputs Menu



Outputs Menu



Configuration Menu



HOA Menu



Graph Menu



Home Page



Filter

Other icons may appear in the menu screens.



Calibration icon appears in sensor input menus and brings up the calibration menu



Graph icon appears in Input menus and brings up the Graphs menu showing that input



Edit icon appears in Input and Output details menus and allows the editing of settings



Information icon appears in Input and Output menus in place of the Edit icon and is used to leave edit mode and return to viewing information related to that Input or Output.



Close icon closes a menu and returns to the previous menu



Confirm icon saves changes and returns to the previous menu



Filter icon is used in menus to limit the choices displayed when selecting items from a list



Character Delete icon erases part of an alphanumeric entry



Shift icon is used for upper-case characters



Double Arrow icons appear in Graphs menu and move the time frame of the graph



Calendar icon appears in Graphs menu and brings up the Time Range settings



Dim and Bright icons appear in Display Settings menu

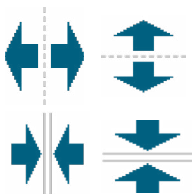

Split icons appear in Edit Home Screen Layout and are used to change a larger cell into two smaller ones

Merge icons appear in Edit Home Screen Layout and are used to change two smaller cells into one larger one



Move Up or Down icons appear in Edit Home Screen Layout and are used to move a parameter up and down in it's position on the screen



Delete icon appears in Edit Home Screen Layout and is used to delete all contents in that section of the Home screen <task_delete>



Return con appears in Output menu HOA Setting and returns to the list of settings for that output. <nav_back>

Overview of the use of icons

Changing Numeric Values

To change a number, use the Character Delete icon to the digit to be changed. If the new number will be negative, start with touching the minus sign, then use the numeric touchpad and decimal point to type the number (some entries must be integers and the decimal will be ignored and the setting rounded to the nearest integer). Once the value of the number is correct touch the Confirm icon to store the new value into memory, or touch the Close icon to leave the number at its previous value and go back.

Changing Names

To change the name used to identify an input or output, use the QWERTY keypad. Upper case and lower case letter, numbers, a blank space, period, and symbols are available. Touching a key and sliding up will enter the character in the upper corner of the key, or bring up that character with its possible accents, if applicable. Double tapping the shift key acts as a caps lock. Once the word is correct, use the Enter icon to store the new value into memory, or use the Close icon to leave the word at its previous value and go back.

Choosing from a List

Selecting the type of sensor connected to an input channel, which sensor will be used as an input for a control algorithm, the units of measure of an input, the control mode used for an output, etc., the selection is picked from a list of available options. Swipe if necessary to find the desired option, and then touch the option to highlight it. Touch the Confirm icon to store the new option into memory or touch the Close icon to leave the selection at its previous value and go back.

The Filter icon may be used to limit the items displayed in the list. Touch the Filter icon to bring up the types of I/O that may be filtered and then touch any that should be filtered out. Most common is to filter out “Unassigned Channels”. Touch the Confirm icon to filter the list or Cancel to show all channels.

Hand-Off-Auto Relay Mode

Touch the desired relay mode. In Hand mode the relay is forced on for a specified amount of time and when that time is up the relay returns to its previous mode, in Off mode the relay is always off until taken out of Off mode, and in Auto mode the relay is responding to control set points. Touch the Return icon to go back to the relay settings.

Interlock and Activate with Channels Menus

To select which digital inputs or relays will interlock this relay (Interlock Channels), or which digital inputs or relays will force this relay on (Activate with Channels), touch the input or relay number(s). The background of the selected item will turn dark. When finished selecting as many as needed, touch the Confirm icon to accept the changes or the Close icon to leave the selections at the previous settings and go back.

4.4 Startup

Initial Startup

After having mounted the enclosure and wired the unit, the controller is ready to be started. Plug in the controller and turn on the power switch to supply power to the unit. The display will briefly show the logo and then revert to the Home display. Refer to section 5 below for more details on each of the settings.

To return Home, Close any active menu and touch the Home tab on the top of the screen.

Config Menu (see section 5.4)

Choose language

Touch the Configuration tab on the top of the Home screen. Touch Global Settings. Swipe up or down until the English word “Language” is displayed and then touch it. Swipe up or down until your language is displayed and touch it. Touch the Confirm icon to change all menus to your language.

Set date (if necessary)

In the Global Setting menu, swipe up or down until Date is displayed, and then touch it. Highlight the Day, and then use the numeric touchpad to change the date. Touch the Confirm icon to accept the change.

Set time (if necessary)

In the Global Setting menu, swipe up or down until Time is displayed and then touch it. Highlight the digit to change, then use the numeric touchpad to change the time. Touch the Confirm icon to accept the change.

Set global units of measure

In the Global Setting menu, swipe up or down until Global Units is displayed and then touch it. Touch the desired units. Touch the Confirm icon to accept the change.

Set temperature units of measure

In the Global Setting menu, swipe up or down until Temp Units is displayed and then touch it. Touch the desired units. Touch the Confirm icon to accept the change.

Close the Global Settings menu. Touch the Inputs tab.

Inputs (see section 5.2)

Program the settings for each input

A list of all available inputs will be displayed. Touch the S11 Input to get to the Details screen. Touch the Edit icon. If the name of the sensor does not describe the type of sensor connected, swipe up or down until Type is displayed. Touch the Type field. Swipe up or down until the correct type of sensor is displayed, then touch it to highlight it. Touch the Confirm icon to accept the change. This will bring you back to the Details screen. Touch the Edit icon and finish the rest of the S11 settings. For copper/nickel sensors select the units of measure.

When finished with S11, touch the Close icon until the list of inputs is displayed. Repeat the process for each input.

The S12 input is the optional pH input for electroless nickel, if a pH sensor will be used, change the Type from No Sensor to pH. This will bring you back to the Settings screen. Finish the rest of the S12 settings.

The S13 temperature input Element should be set to RTD 1000Ω if the S12 pH sensor includes a temperature element. If so, set the alarm set points and alarm deadband. To calibrate the temperature, return to the S13 Details screen, touch the Calibrate icon, and touch the Enter icon to perform a calibration.

If the other input card is a Dual Analog Input card (4-20mA signal), then select the type of sensor that will be connected. Select AI Monitor if the device can be calibrated on its own and the W600 calibration will only be in units of mA. Select Transmitter if the device connected cannot be calibrated on its own and the W600 will need to be used to calibrate in engineering units of measure.

If a flow switch or liquid level switch is connected, D1 through D6 (whichever one has the device connected to it) should be set to DI State type (if no switch is connected, select No Sensor). Set the state that will possibly interlock control outputs (refer to the Outputs settings to program which outputs, if any, will be interlocked by the switch). Set the state, if any, that will result in an alarm.

If a contacting head or paddlewheel flow meter is connected, D1 through D6 (whichever one has the device connected to it) should be set to that type (if no flow meter is connected, select No Sensor). Set the units of measure, volume/contact or K factor, etc.

Calibrate the copper/nickel and optional pH sensor

To calibrate the sensor, return to the list of inputs, touch the sensor to calibrate, touch the Calibrate icon, and select one of the calibration routines. For copper/nickel sensors, start with a Water/Sample Calibration. After that, a calibration offset setting can be applied, to match the reading to a titration, from the Settings menu. Refer to section 5.2.

Touch the Main Menu icon. Touch the Outputs icon.

Outputs (see section 5.3)

Program the settings for each output

A list of all available outputs will be displayed. Touch the relay to program first to get to the Details screen. Touch the Edit icon. If the name of the relay does not describe the control mode desired, swipe up or down until the Mode menu is displayed. Touch the Mode menu. Swipe up or down until the correct control mode is displayed and touch it. This will bring you back to the Details screen. Touch the Edit icon and finish the rest of the output's settings.

If you want the output to be interlocked by a flow switch or by another output being active, enter the Interlock Channels menu and select the input or output channel that will interlock this output.

The default is for the output to be in Off mode, where the output does not react to the settings. Once all settings for that output are complete, enter the HOA Setting menu and change it to Auto.

Repeat for each output.

The default setting is for R1 to be used for the copper or nickel replenishment, using the Plating Control mode. This mode allows for totalizing the amount of metal fed by logging the time, or converting time to volume using the replenishment pump output, or by metal turnovers. Select this using the Total Mode menu. If using a copper sensor, select the Control direction as Electroless (force higher) or Microetch (force lower).

Select Plating Control for the pH control relay in an electroless nickel application to get the same Total Mode choices. If totalizing by volume is not a priority, choose On/Off or Time Proportional.

R2-R4 default to Plating Follow mode. These relays will activate at the same time as the relay feeding metal (R1 is the default, select the proper relay for your installation). The intention is to feed pH adjustment, reducing agent, and/or stabilizer in proportion to the metal.

Home Screen Setup (see section 5.4.9)

Once the controller has been programmed for the intended purpose, the parameters that are displayed on the Home screen, their size, and position can be customized. The default is to display the first two sensor inputs on the left side of the first page and the status of eight relays on the right side, with nothing on the optional second or third page.

From the Configuration tab, touch Display Settings, and then Edit Home Screen Layout. Touch the parameter name to change the parameter shown. Touch the Split icons to make two smaller cards from one larger card, or touch the Merge icons to make two smaller cards into one larger one. Select the parameter to be shown in each card. Swipe to the next page and add more cards if desired. Use the delete icon to remove everything from that half-screen display panel. Use the Move Up or Down icons to move the entire display panel up or down.

Touch the Confirm icon to save the changes or Close to cancel the setting changes.

Normal Startup

Startup is a simple process once your set points are in memory. Simply check your supply of chemicals, turn on the controller, calibrate it if necessary and it will start controlling.

4.5 Shut Down

To shut the controller down, simply turn off the power. Programming remains in memory. It is important that the pH/ORP electrode and disinfection sensors remain wet. If the shutdown is expected for any longer than a day, and it is

possible for the electrode to dry out, remove the electrode from the tee and store it in pH 4 buffer or cooling tower water. Take care to avoid freezing temperatures when storing the pH/ORP electrodes to avoid breakage of the glass.

5.0 OPERATION using the touchscreen

These units control continuously while power is applied. Programming is accomplished either via the touchscreen or the optional Ethernet connection. See section 6.0 for Ethernet instructions.

To view the readings of each sensor, or whatever user-defined list of parameters that has been set, touch the Home icon if not already there. The menus for each of these parameters may be accessed directly by touching the parameter.

Keep in mind that even while browsing through menus, the unit is still controlling.

The menu structure is grouped by alarms, inputs and outputs, graphs and HOA. Under the Configuration menu will be general settings such as the clock, the language, etc. that do not have an input or output associated with it. Each input has its own menu for calibration and unit selection as needed. Each output has its own setup menu including set points, timer values and operating modes as needed. Each output has its own setup menu including set points, timer values and operating modes as needed.

MAIN MENU / HOME SCREEN OVERVIEW

INPUTS

Home	Inputs	Outputs	Graphs	HOA	Config	Alert
Nickel (S11)	Temp (S12)					
5.25 g/l	125.2 °F					
pH (S12)	Flowswitch (D1)					
4.60	Flow					
Unassigned (D2)	Unassigned (D3)					
Unassigned (D4)	Unassigned (D5)					

List of Possible Inputs

Copper	Flowmeter, Analog Type
Nickel	DI State
Contacting Conductivity	Flow Meter, Contactor type
Electrodeless Conductivity	Flow Meter, Paddlewheel type
Temperature	Feed Monitor
pH	Counter
ORP	DI Counter
Disinfection	Calculation Virtual Input
Generic	Redundant Sensor Virtual Input
Transmitter/AI Monitor	Raw Value Virtual Input
Fluorometer	

OUTPUTS

Home	Inputs	Outputs	Graphs	HOA	Config	Alert
Nickel Control (R1)	pH Control (R2)					
On	Off					
Hypo Control (R3)	Temp Alarm (R4)					
Off	Off					
Manual (R5)	Alarm (R6)					
Off	Off					

List of Possible Outputs

Plating Control	Timer control mode
Plating Follow	Probe Wash control mode
On/Off control mode	Spike control mode
Flow Timer control mode	Lag Output control mode
Bleed & Feed control mode	Flow Meter Ratio control mode
Percent Timer control mode	Counter Timer
Biocide Timer control mode	Dual Switch
Alarm Output mode	Analog Output, Retransmit mode
Time Proportional control mode	Analog Output, Proportional control mode
Pulse Proportional control mode	Analog Output, Manual mode
Intermittent Sampling mode	
Manual control mode	
PID control mode	
Dual Setpoint mode	

ALARMS (List of Active Alarms)

Home	Inputs	Outputs	Graphs	HOA	Config	Alert
Temp (S12) Sensor Fault						

HOME SCREEN (example)

Home	Inputs	Outputs	Graphs	HOA	Config	Alert
Nickel (S11)	Nickel Control (R1)	On				
5.25 g/l	pH Control (R2)	Off				
pH (S12)	Hypo Control (R3)	Off				
4.60	Temp Alarm (R4)	Off				
Temp (S13)	Manual (R5)	Off				
125.6 °F	Alarm (R6)	Off				
Flowswitch (D1)	Retrans (A1)	0.0 %				
Flow	Manual (A2)	0.0 %				

CONFIG

Home	Inputs	Outputs	Graphs	HOA	Config	Alert
Global Settings		Security Settings				
Ethernet Settings		Ethernet Details				
Remote Communications		Email Report Settings				
Display Settings		File Utilities				
Controller Details						

HOA

Home	Inputs	Outputs	Graphs	HOA	Config	Alert
Nickel Control (R1)	Hand	Off	Auto			
pH Control (R2)	Hand	Off	Auto			
Hypo Control (R3)	Hand	Off	Auto			
Temp Alarm (R4)	Hand	Off	Auto			
Manual (R5)	Hand	Off	Auto			
Alarm (R6)	Hand	Off	Auto			

GRAPHS

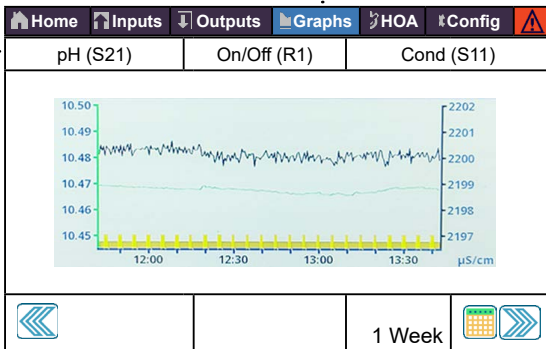

Graph Settings

Left Sensor
Low Axis Limit
High Access Limit
DI / Relay

Additional Settings:
Right Sensor
Low Axis Limit
High Axis Limit
Time Range

Graph Settings

Time Range

30 Minutes
1 Hour
2 Hours
3 Hours
6 Hours

Additional Settings:
12 Hours
1 Day
1/2 week
1 Week
2 Weeks
4 Weeks

INPUTS

Home	Inputs	Outputs	Graphs	HOA	Config	Alert
Nickel (S11)	Temp (S12)					
5.25 g/l	125.2 °F					
pH (S12)	Flowswitch (D1)					
4.60	Flow					
Unassigned (D2)	Unassigned (D3)					
Unassigned (D4)	Unassigned (D5)					

List of Possible Inputs

Copper
Nickel
Contacting Conductivity
Electrodeless Conductivity
Temperature
pH
ORP
Disinfection
Generic
Transmitter/AI Monitor
Fluorometer

Flowmeter, Analog Type
DI State
Flow Meter, Contactor type
Flow Meter, Paddlewheel type
Feed Monitor
Counter
DI Counter
Calculation Virtual Input
Redundant Sensor Virtual Input
Raw Value Virtual Input

Contacting Conductivity (S11)

1000 µS/cm

Alarms
Status
Raw Value
Temperature
etc. Details Screen Content varies with sensor type

Additional Input Details:

24-Hour Minimum Maximum and Averages
Calibration Gain and Offset
Last Calibration
Type
Sensor Board

Contacting Conductivity (S11)

1000 µS/cm

Water/Sample Calibration (Cu/Ni inputs only)
One-Point Process Calibration
One-Point Buffer Calibration
Open Air Calibration (Conductivity inputs only)

Additional Calibration Options:

Zero Calibration (Disinfection inputs only)
Two-Point Buffer Calibration (pH/ORP inputs only)
Three-Point Buffer Calibration (pH/ORP inputs only)
One-Point Analog Calibration (4-20 mA inputs only)
Two-Point Analog Calibration (4-20 mA inputs only)

Contacting Cond (S11-23)

1000 µS/cm

LoLo Alarm
Low Alarm
High Alarm
HiHi Alarm

Additional Settings for Contacting Conductivity:

Temp Comp Factor Units
Cell Constant Name
Cable Length Type
Gauge

ORP (S11-23)

500 mV

LoLo Alarm
Low Alarm
High Alarm
HiHi Alarm

Additional Settings for ORP Sensor:

Deadband Gauge
Reset Calibration Values Name
Cal Required Alarm Type
Alarm & Datalog Suppression
Smoothing Factor
Cable Length

Copper/Nickel (S11,S21)

7.05 g/l

LoLo Alarm
Low Alarm
High Alarm
HiHi Alarm

Additional Settings for Copper/Nickel:

Deadband Smoothing Factor
Calibration Offset Stabilization Time
Reset Calibration Value Units
Cal Required Alarm Name
Alarm Suppression Type

Disinfection (S11-23)

2.0 ppm

LoLo Alarm
Low Alarm
High Alarm
HiHi Alarm

Additional Settings for Disinfection Sensor:

Deadband Smoothing Factor
Reset Calibration Cable Length
Values Gauge
Cal Required Alarm Name
Alarm & Datalog Suppres- Sensor
sion Type

Electrodeless Cond (S11-23)

1000 µS/cm

LoLo Alarm
Low Alarm
High Alarm
HiHi Alarm

Additional Settings for Electrodeless Conductivity:

Deadband Temp Compensation
Reset Calibration Values Temp Comp Factor
Cal Required Alarm Cell Constant
Alarm & Datalog Suppression Cable Length
Smoothing Factor Gauge
Default Temp Units
Installation Factor Name
Range Type

Generic (S11-S23)

20.0 ppm

LoLo Alarm
Low Alarm
High Alarm
HiHi Alarm

Additional Settings for Generic Sensor:

Deadband Low / High Range
Reset Calibration Values Cable Length
Cal Required Alarm Gauge
Alarm & Datalog Suppres- Units
sion Electrode (Linear or Ion
Smoothing Factor Selective)
Sensor Slope Name
Sensor Offset Type

Temperature (S11-23)

20 °C

LoLo Alarm
Low Alarm
High Alarm
HiHi Alarm

Additional Settings:

Deadband Smoothing Factor
Reset Calibration Values Name
Cal Required Alarm Element
Alarm & Datalog Suppression

Transmitter / AI Monitor (S11-S23)

100%

LoLo Alarm
Low Alarm
High Alarm
HiHi Alarm

Additional Settings for Transmitter and AI Monitor:

Deadband Transmitter
Reset Calibration Values 4 mA Value
Cal Required Alarm 20 mA Value
Alarm & Datalog Suppres- Units
sion Name
Smoothing Factor Type

pH (S11-23)

7.00

LoLo Alarm
Low Alarm
High Alarm
HiHi Alarm

Additional Settings for pH Sensor:

Deadband Cable Length
Reset Calibration Values Gauge
Cal Required Alarm Electrode
Alarm & Datalog Suppression Name
Smoothing Factor Type
Buffers (pH only)
Default Temp

Fluorometer (S11-S23)

20 ppm

LoLo Alarm
Low Alarm
High Alarm
HiHi Alarm





Additional Settings for Fluorometer:

Deadband Transmitter
Reset Calibration Values Max Sensor Range
Cal Required Alarm Dye / Product Ratio
Alarm & Datalog Suppres- Name
sion Type
Smoothing Factor

DIGITAL INPUTS

VIRTUAL INPUTS

DI State (D1-D6)





No Flow    

LoLo Alarm
Low Alarm
High Alarm
HiHi Alarm

Additional Settings for DI State:

Open Message	Total Time
Closed Message	Reset Time Total
Interlock	Name
Alarm	Type
Alarm & Datalog	
Suppression	

Calculation (V1-V6)

1000 μ S/cm    





LoLo Alarm
Low Alarm
High Alarm
HiHi Alarm

Additional Settings for Calculation:

Deadband	Alarm & Datalog
Input	Suppression
Constant	Low Range
Input 2	High Range
Constant 2	Smoothing Factor
Calculation Mode	Name
	Type

Contactor Type

Flowmeter (D1-D6)





100 gal    

LoLo Alarm
Low Alarm
High Alarm
HiHi Alarm

Additional Settings for Contactor, Flowmeter:

Totalizer Alarm	Volume/Contact
Reset Flow Total	Flow Units
Set Flow Total	Name
Scheduled Reset	Type
Alarm & Datalog	
Suppression	

Redundant (V1-V6)

1000 μ S/cm    





LoLo Alarm
Low Alarm
High Alarm
HiHi Alarm

Additional Settings for Redundant:

Deviation Alarm	Input
Deadband	Input 2
Alarm & Datalog	Name
Suppression	Type
Mode	

Paddlewheel Type

Flowmeter (D1-D6)





100 g/m    

LoLo Alarm
Low Alarm
High Alarm
HiHi Alarm

Additional Settings for Paddlewheel, Flowmeter:

Deadband	K Factor
Alarm & Datalog	Flow Units
Suppression	Rate Units
Set Flow Total	Smoothing Factor
Totalizer Alarm	Name
Reset Flow Total	Type

Raw Value (V1-V6)





1000 μ S/cm    

LoLo Alarm
Low Alarm
High Alarm
HiHi Alarm

Additional Settings for Raw Value:

Deadband	Type
Alarm & Datalog	
Suppression	
Input	
Smoothing Factor	
Name	

Feed Monitor (D1-D6)





1.0 gal    

LoLo Alarm
Low Alarm
High Alarm
HiHi Alarm

Additional Settings for Feed Monitor:

Totalizer Alarm	Reprime Time
Reset Flow Total	Volume/Contact
Set Flow Total	Flow Units
Scheduled Reset	Rate Units
Total Alarm Mode	Smoothing Factor
Flow Alarm Mode	Output
Flow Alarm Delay	Name
Flow Alarm Clear	Type
Deadband	

DI Counter (D1-D6)

1000    

LoLo Alarm
Low Alarm
High Alarm
HiHi Alarm

Additional Settings for DI Counter:

Deadband	Units
Alarm & Datalog	Rate Units
Suppression	Units per Pulse
Totalizer Alarm	Smoothing Factor
Reset Total	Name
Set Total	Type
Scheduled Reset	

OUTPUTS

Home Inputs Outputs Graphs HOA Config	
Nickel Control (R1)	pH Control (R2)
On	Off
Hypo Control (R3)	Temp Alarm (R4)
Off	Off
Manual (R5)	Alarm (R6)
Off	Off

List of Possible Outputs

- Plating Control
- Plating Follow
- On/Off control mode
- Flow Timer control mode
- Bleed & Feed control mode
- Percent Timer control mode
- Biocide Timer control mode
- Alarm Output mode
- Time Proportional control mode
- Pulse Proportional control mode
- Intermittent Sampling mode
- Manual control mode
- PID control mode
- Dual Setpoint mode
- Timer control mode
- Probe Wash control mode
- Spike control mode
- Lag Output control mode
- Flow Meter Ratio control mode
- Counter Timer
- Dual Switch
- Analog Output, Retransmit mode
- Analog Output, Proportional control mode
- Analog Output, Manual mode

On/Off (R1)

Off ✎ ✕

Status

Time On

24 hour time

Total Time

etc. Details Screen Content varies with output type

Additional Input Details:

- Alarms
- Input Value
- Mode
- Relay Type

RELAY OUTPUTS & VIRTUAL (CONTROL) OUTPUTS

Plating Control (R1-R6, C1-C6)

Off ℹ ✕

HOA Setting

Setpoint

Deadband

Duty Cycle Period

Additional settings for Plating Control Mode:

- Duty Cycle
- On Delay Time
- Off Delay Time
- Total Mode
- Output Time Limit
- Reset Output Timeout
- Interlock Channels
- Activate with Channels
- Minimum Relay Cycle
- Hand Time Limit
- Input
- Control
- Name
- Mode

Plating Follow (R1-R6, C1-C6)

Off ℹ ✕

HOA Setting

Total Mode

Reset Total

Interlock Channels

Additional Settings for Plating Follow Mode:

- Activate with Channels
- Minimum Relay Cycle
- Hand Time Limit
- Control
- Name
- Mode

On/Off (R1-R6, C1-C6)

Off ℹ ✕

HOA Setting

Setpoint

Deadband

Duty Cycle Period

Additional settings for On/Off Mode:

- Duty Cycle
- On Delay Time
- Off Delay Time
- Daily Max Time
- Output Time Limit
- Reset Output Timeout
- Interlock Channels
- Activate with Channels
- Minimum Relay Cycle
- Hand Time Limit
- Reset Time Total
- Input
- Direction
- Name
- Mode

Flow Timer (R1-R6, C1-C6)

Off ℹ ✕

HOA Setting

Feed Duration

Accumulated Volume



Reset Timer

Additional Settings for Flow Timer Mode:

- Daily Max Time
- Output Time Limit
- Reset Output Timeout
- Interlock Channels
- Activate with Channels
- Minimum Relay Cycle
- Hand Time Limit
- Reset Time Total
- Flow Input
- Flow Input 2
- Name
- Mode

RELAY OUTPUTS & VIRTUAL (CONTROL) OUTPUTS

Percent Timer (R1-R6, C1-C6)

Off  



HOA Setting
Sample Period
Feed Percentage
Output Time Limit

Additional settings for Percent Timer Mode:

Reset Output Timeout
Interlock Channels
Activate with Channels
Minimum Relay Cycle

Hand Time Limit
Reset Time Total
Name
Mode

Dual Setpoint (R1-R6, C1-C6)

Off  



HOA Setting
Set Point
Set Point 2
Deadband

Additional settings for Dual Setpoint Mode:

Duty Cycle Period
Duty Cycle
On Delay Time
Off Delay Time
Output Time Limit
Reset Output Timeout
Interlock Channels
Activate with Channels

Minimum Relay Cycle
Hand Time Limit
Reset Time Total
Input
Direction
Name
Mode

Alarm (R1-R6, C1-C6)

Off  



HOA Setting
Alarm Mode
On Delay Time
Off Delay Time

Additional settings for Alarm Mode:

Select Alarms
Output
Interlock Channels
Activate with Channels
Minimum Relay Cycle

Hand Time Limit
Reset Time Total
Name
Mode

Probe Wash (R1-R6, C1-C6)

Off  



HOA Setting
Event 1 (through 10)
Repetition
Hourly

Additional settings for Probe Wash Mode:

Week
Day
Events Per Day
Start Time
Duration
Input
Input 2
Sensor Mode
Hold Time

Interlock Channels
Activate with Channels
Channels
Minimum Relay Cycle
Hand Time Limit
Reset Time Total
Name
Mode

Time Prop (R1-R6, C1-C6)

Off  

HOA Setting
Set Point
Proportional Band
Sample Period

Additional settings for Time Prop Mode:

Daily Max Time
Output Time Limit
Reset Output Timeout
Interlock Channels
Activate with Channels
Minimum Relay Cycle

Hand Time Limit
Reset Time Total
Input
Direction
Name
Mode

Not available for virtual outputs

Lag Control (R1-R6)

Off

HOA Setting
Lead
Wear Leveling*
Wear Cycle Time*

Additional settings for Lag Control Mode:



Activation Mode*
Set Point
Set Point 2
Deadband
Delay Time*
Output Time Limit
Reset Output Timeout
Interlock Channels

Activate with Channels
Min Relay Cycle
Hand Time Limit
Reset Time Total
Name
Mode

* See section 5.3.18

Only if Pulse Relay Type

Flow Prop (R1-R6, C1-C6)

Off  



HOA Setting
Target
Pump Capacity
Pump Setting

Additional settings for Flow Prop Control Mode:

Specific Gravity
Maximum Rate
Output Time Limit
Reset Output Timeout
Interlock Channels
Activate with Channels
Hand Time Limit

Reset Time Total
Flow Input
Cycles Input
Low Cycles Limit
Name
Mode

Manual (R1-R6, C1-C6)

Off  

HOA Setting
On Delay Time
Off Delay Time
Output Time Limit



Additional settings for Manual Mode:

Reset Output Timeout
Interlock Channels
Minimum Relay Cycle
Hand Time Limit
Reset Time Total

Name
Mode

Only if Pulse Relay Type

Pulse Prop (R1-R6, C1-C6)

Off  

HOA Setting
Set Point
Proportional Band
Minimum/Maximum Output



Additional settings for Pulse Prop Mode:

Maximum Rate
Interlock Channels
Activate with Channels
Minimum Relay Cycle
Hand Time Limit

Reset Time Total
Input
Direction
Name
Mod

RELAY OUTPUTS & VIRTUAL (CONTROL) OUTPUTS

Spike Control (R1-R6, C1-C6)

Off  



HOA Setting
Set point
Spike Setpoint
Deadband

Additional settings for Spike Control Mode:

Onset Time	Reset Output Timeout
Duty Cycle Period	Interlock Channels
Duty Cycle	Activate With Channels
Event 1 (through 6)	Min Relay Cycle
Repetition	Hand Time Limit
Week	Reset Time Total
Day	Input
Start Time	Direction
Duration	Name
Daily Max Time	Mode
Output Time Limit	

Not available for virtual outputs

Manual Control (A1-A2)



Off  

HOA Setting
Interlock Channels
Activate with Channels
Minimum Relay Cycle

Additional settings for Manual Control Mode:

Hand Time Limit	Name
Reset Time Total	Mode

Flow Meter Ratio (R1-R6, C1-C6)



Off  

HOA Setting
Accumulator Volume
Bleed Volume
Reset Timer

Additional settings for Flow Meter Ratio:

Daily Max Time	Makeup Meter
Output Time Limit	Makeup Meter 2
Reset Output Timeout	Bleed Meter
Interlock Channels	Bleed Meter 2
Activate with Channels	Disturbance Input
Minimum Relay Cycle	Name
Hand Time Limit	Mode
Reset Time Total	

Flow Prop (A1-A2, C1-C6)



Off  

HOA Setting
Target
Pump Rating
Pump Setting

Additional settings for Flow Prop Control Mode:

Specific Gravity	Error Output
Output Time Limit	Reset Time Total
Reset Output Timeout	Flow Input
Interlock Channels	Cycles Input
Activate with Channels	Low Cycles Limit
Hand Output	Name
Hand Time Limit	Mode
Off Mode Output	

Dual Switch (R1-R6,C1-C6)

Off  



HOA Setting
On Switch
Activate On
On Delay Time

Additional settings for Dual Switch Mode:

Off Switch	Interlock Channels
Activate O	Activate with Channels
Off Delay Time	Min Relay Cycle
Hand Time Limit	Reset Time Total
Daily Max Time	Name
Output Time Limit	Mode
Reset Output Timeout	

Not available for virtual outputs

Lag Output (A1-A2)

Off  



HOA Setting
Lead
Reset Time Total
Output Time Limit

Additional settings for Lag Output Mode:

Reset Output Timeout
Wear Leveling
Wear Cycle Time
Name
Mode

Not available for virtual outputs

Retransmit (A1-A2)



Off  

HOA Setting
4 mA Value
20 mA Value
Hand Output

Additional settings for Retransmit Mode:

Error Output
Reset Time Total
Input
Name
Mode

Prop Control (A1-A2, C1-C6)



Off  

HOA Setting
Set Point
Proportional Band
Min Output

Additional settings for Proportional Control Mode:

Max Output	Total
Output Time Limit	Off Mode Output
Reset Output Timeout	Error Output
Interlock Channels	Input
Activate with Channels	Direction
Hand Output	Name
Hand Time Limit	Mode
Reset Time	

PID Control (A1-A2, C1-C6)

Off  

HOA Setting
Set Point
Gain
Proportional Gain

Additional settings for PID Control Mode:

Integral Time	Hand Output
Integral Gain	Hand Time Limit
Derivative Time	O Mode Output
Derivative Gain	Error Output
Reset PID Integral	Reset Time Total
Min Output	Input
Max Output	Direction
Max Rate	Input Minimum
Output Time Limit	Input Maximum
Reset Output Timeout	Gain Form
Interlock Channels	Name
Activate with Channels	Mode

CONFIG MENU

Home Inputs Outputs Graphs HOA Config Alerts	
Global Settings	Security Settings
Ethernet Settings	Ethernet Details
Remote Communications	Email Report Settings
Display Settings	File Utilities
Controller Details	

Remote Communications

Comm Status
 Data Format
 Data Port
 Verbose Logging

Swipe for additional settings for Remote Communications:

Device ID
Network

File Utilities

File Transfer Status
 Data Log Export
 Periodic Log Export
 Export Event Log

Swipe for additional settings for File Utilities:

Export System Log Software Upgrade
 Export User Config File
 Import User Config File
 Repair Network File System
 Restore Default Config

Global Settings

Date
 Time
 Name
 Location

Swipe to additional settings for Global Settings:

Global Units
 Temperature Units
 Alarm Delay
 Language

Controller Details

Controller
 Product Name
 Serial Number
 Last Data Log

Swipe for additional settings for Controller Details:

Software Version Network Board
 Power Board Software Version
 AO Board Battery Power
 Sensor Board #1 Processor Temp
 Software Version Network Temp
 Sensor Board #2 I/O Card 1 Temp
 Software Version I/O Card 2 Temp
 Last Data Log Network Temp
 Digital Inputs +5 Volt Supply
 Software Version +3.3 Volt Supply

Display Settings

Edit Home Screen Layout
 Splash Protection
 Activate Splash Protection
 Adjust Display

Swipe to additional settings for Display Settings:

Auto Dim Time
 Key Beep

Security Settings

Controller Log Out
 Security
 Local Password

Email Report Settings

Report #1 through #4
 Email Addresses
 Email Server
 SMTP Server

Swipe for additional settings for Email Report Settings:

SMTP Port Day (Datalog/Summary Reports/Graph)
 From Address Reports/Graph)
 ASMTMP Username Day of Month (Datalog/Summary Reports/Graph)
 ASMTMP Password Summary Reports/Graph)
 Test Report Recipients Report Time (Datalog/Summary Reports/Graph)
 Send Email Test Report Summary Reports/Graph)
 Report #1-4 Settings: Log Frequency (Datalog Report)
 Report Type Alarm Mode (Alarms Report)
 Email Recipients Select Alarms (Alarms Report)
 Repetition (Datalog/Summary Reports/Graph) Alarm Delay (Alarms Report)
 Reports/Graph) Attach Summary (Alarms Report)
 Reports Per Day (Datalog/Summary Reports/Graph) Report

Ethernet Settings

DHCP Setting
 Controller IP Address
 Netmask
 Gateway

Swipe for additional settings for Ethernet Settings:

DNS Server Reply Timeout
 Web Server
 Web Page Color Scheme
 Fluent Alarm Delay
 TCP Timeout
 Fluent Status
 LiveConnect Status
 Update Period

Ethernet Details

Ethernet Status
 Alarms
 DHCP Status
 Controller IP

Swipe for additional information on Ethernet Details:

Netmask
 Gateway
 DNS Server
 Web Server
 MAC Address
 Last Fluent Data
 Last Fluent Config
 Live Connect Status

5.1 Alarms Menu



Touch the Alarms icon to view a list of active alarms. If there are more than six active alarms, the Page Down icon will be shown; touch this icon to bring up the next page of alarms.

Touch the Main Menu icon to go back to the previous screen.

5.2 Inputs Menu



Touch the Inputs icon to view a list of all sensor and digital inputs.

Touch the input to access that input's details, calibration (if applicable) and settings.

Sensor Input Details

The details for any type of sensor input include the current value read, alarms, the raw (uncalibrated) signal, the sensor type, and the calibration gain and offset. If the sensor has automatic temperature compensation, then the sensor's temperature value and alarms, the temperature resistance value read, and the type of temperature element required are also displayed under a separate sensor input menu.

Calibration



Touch the Calibration icon to calibrate the sensor. Select the calibration to perform: Water/Sample Calibration, One Point Process, One Point Buffer, Two Point Buffer, Three Point Buffer, One Point Analog, or Two Point Analog Calibration. Not all calibration options are available for all types of sensor.

Water/Sample Calibration

Begin Calibration

OK to disable control?

Touch Confirm to continue or Cancel to abort.

Remove Sensor

Please provide water sample to sensor

Place the immersible sensor in clean tap or DI water, or circulate through the flow through sensor. Touch Confirm to continue or Cancel to abort.

Stabilization

When the signal from the sensor is stable, the controller will automatically move to the next step. If it doesn't stabilize you may manually go to the next step by touching Confirm.

Process Sample

Enter the value of the process solution to be used to calibrate and touch Confirm.

Process Sample

Please provide process sample to sensor

Place the immersible sensor in the process sample, or circulate through the flow through sensor. Touch Confirm to continue or Cancel to abort.

Stabilization

When the signal from the sensor is stable, the controller will automatically move to the next step. If it doesn't stabilize you may manually go to the next step by touching Confirm.

Calibration Successful or Failed

If successful, touch Confirm to put the new calibration in memory. The calibration adjusts the water offset and slope and displays the new slope and the mV in water at both measurement and reference wavelengths. If failed, you may retry the calibration or cancel. Refer to Section 8 to troubleshoot a calibration failure.

Resume Control

Replace the sensor in the process and touch Confirm when ready to resume control.

One Point Process Calibration

New Value

Enter the actual value of the process as determined by another meter or laboratory analysis and touch Confirm.

Cal Successful or Failed

If successful, touch Confirm to put the new calibration in memory.

If failed, you may retry the calibration or cancel. Refer to Section 8 to troubleshoot a calibration failure.

One Point Buffer Calibration, Disinfection/Generic Sensor Zero Cal, Conductivity Air Cal

Cal Disables Control

Touch Confirm to continue or Cancel to abort

Buffer Temperature (only appears if no temperature sensor is detected for sensor types that use automatic temperature compensation)

Enter the temperature of the buffer and touch Confirm.

Buffer Value (only appears for One Point Calibration except when automatic buffer recognition is used)

Enter the value of the buffer being used

Rinse Sensor

Remove the sensor from the process, rinse it off, and place it in the buffer solution (or oxidizer-free water for Zero Cal, or air for the conductivity open air cal). Touch Confirm when ready.

Stabilization

When the temperature (if applicable) and signal from the sensor is stable, the controller will automatically move to the next step. If they don't stabilize you may manually go to the next step by pressing Confirm.

Cal Successful or Failed

If successful, touch Confirm to put the new calibration in memory.

If failed, you may retry the calibration or cancel. Refer to Section 8 to troubleshoot a calibration failure.

Resume Control

Replace the sensor in the process and touch Confirm when ready to resume control.

Two Point Buffer Calibration

Cal Disables Control

Touch Confirm to continue or Cancel to abort

Buffer Temperature (only appears if no temperature sensor is detected for sensor types that use automatic temperature compensation)

Enter the temperature of the buffer and touch Confirm.

First Buffer Value (does not appear if automatic buffer recognition is used)

Enter the value of the buffer being used

Rinse Sensor

Remove the sensor from the process, rinse it off, and place it in the buffer solution. Touch Confirm when ready.

Stabilization

When the temperature (if applicable) and signal from the sensor is stable, the controller will automatically move to the next step. If they don't stabilize you may manually go to the next step by touching Confirm.

Second Buffer Temperature (only appears if no temperature sensor is detected for sensor types that use automatic temperature compensation)

Enter the temperature of the buffer and press Confirm.

Second Buffer Value (does not appear if automatic buffer recognition is used)

Enter the value of the buffer being used

Rinse Electrode

Remove the sensor from the process, rinse it off, and place it in the buffer solution. Touch Confirm when ready.

Stabilization

When the temperature (if applicable) and signal from the sensor is stable, the controller will automatically move to the next step. If they don't stabilize you may manually go to the next step by touching Confirm.

Cal Successful or Failed

If successful, touch Confirm to put the new calibration in memory. The calibration adjusts the offset and the gain (slope) and displays the new values. If failed, you may retry the calibration or cancel. Refer to Section 8 to troubleshoot a calibration failure.

Resume Control

Replace the sensor in the process and touch Confirm when ready to resume control.

Three Point Buffer Calibration (pH sensors only)

Cal Disables Control

Touch Confirm to continue or Cancel to abort

Buffer Temperature (only appears if no temperature sensor is detected)

Enter the temperature of the buffer and touch Confirm.

First Buffer Value (does not appear if automatic buffer recognition is used)

Enter the value of the buffer being used

Rinse Sensor

Remove the sensor from the process, rinse it off, and place it in the buffer solution. Touch Confirm when ready.

Stabilization

When the temperature (if applicable) and signal from the sensor is stable, the controller will automatically move to the next step. If they don't stabilize you may manually go to the next step by touching Confirm.

Second Buffer Temperature (only appears if no temperature sensor is detected)

Enter the temperature of the buffer and touch Confirm.

Second Buffer Value (does not appear if automatic buffer recognition is used)

Enter the value of the buffer being used

Rinse Electrode

Remove the sensor from the process, rinse it off, and place it in the buffer solution. Touch Confirm when ready.

Stabilization

When the temperature (if applicable) and signal from the sensor is stable, the controller will automatically move to the next step. If they don't stabilize you may manually go to the next step by touching Confirm.

Third Buffer Temperature (only appears if no temperature sensor is detected)

Enter the temperature of the buffer and touch Confirm.

Third Buffer Value (does not appear if automatic buffer recognition is used)

Enter the value of the buffer being used

Rinse Electrode

Remove the sensor from the process, rinse it off, and place it in the buffer solution. Touch Confirm when ready.

Stabilization

When the temperature (if applicable) and signal from the sensor is stable, the controller will automatically move to the next step.

Cal Successful or Failed

If successful, touch Confirm to put the new calibration in memory. The calibration adjusts the offset, gain (slope) and calibration midpoint and displays the new values. If failed, you may retry the calibration or cancel. Refer to Section 7 to troubleshoot a calibration failure.

Resume Control

Replace the sensor in the process and touch Confirm when ready to resume control.

One Point Analog Calibration

OK to disable control? Touch Confirm to continue or Cancel to abort.

Input Value

Enter the mA value that the transmitter will be sending. Touch Confirm to continue or Cancel to abort.

Please set input signal to specified value

Make sure that the transmitter is sending the desired mA signal. Touch Confirm to continue or Cancel to abort.
Automatic circuit calibration in progress

Cal Successful or Failed

If successful, touch Confirm to save calibration results. The calculated offset will be displayed.

If failed, you may retry the calibration or cancel. You may also restore calibration to the factory defaults. The calibration will fail if the measured mA is more than 2 mA away from the Input Value entered.

Please restore input signal to process value

Put the transmitter back into normal measurement mode if necessary and touch Confirm when ready to resume control.

Two Point Analog Calibration

OK to disable control? Touch Confirm to continue or Cancel to abort.

Input Value

Enter the mA value that the transmitter will be sending. Touch Confirm to continue or Cancel to abort.

Please set input signal to specified value

Make sure that the transmitter is sending the desired mA signal. Touch Confirm to continue or Cancel to abort.
Automatic circuit calibration in progress

Second Input Value

Enter the mA value that the transmitter will be sending. Touch Confirm to continue or Cancel to abort.

Please set input signal to specified value

Make sure that the transmitter is sending the desired mA signal. Touch Confirm to continue or Cancel to abort.
Automatic circuit calibration in progress

Cal Successful or Failed

If successful, touch Confirm to save calibration results. The calculated offset and gain will be displayed.

If failed, you may retry the calibration or cancel. You may also restore calibration to the factory defaults. The calibration will fail if the offset is more than 2 mA or the gain is not between 0.5 and 2.0.

Please restore input signal to process value

Put the transmitter back into normal measurement mode if necessary and touch Confirm when ready to resume control.

5.2.1 Copper/Nickel

Settings 

Touch the Settings icon to view or change the settings related to the sensor.

Alarms	Low-Low, Low, High and High-High Alarms limits may be set.
---------------	--

Deadband	This is the Alarm Deadband. For example, if the High Alarm is 3 g/l, and the deadband is 0.10, the alarm will activate at 3.01 g/l and deactivate at 2.90 g/l.
Calibration Offset	<p>This menu is used to change the sensor reading without performing a water/sample calibration. This calibration is best performed at normal operating temperature.</p> <p>Keep the immersible sensor in place or have solution flowing through the flow-through sensor. Take a sample of the solution and note the concentration displayed by the controller. Carefully perform the normal laboratory analysis of the metal concentration. Calculate the offset by subtracting the displayed value from the lab results. If the lab analysis is significantly different, adjust the offset using the arrow keys to change the value and the +/- sign. If the controller's display is higher than the lab analysis, the offset should be negative.</p> <p>The maximum offset for calibration offset is 10 g/l or oz/gal from the last water/sample calibration value. If you have an offset larger than this, then perform a new water/sample calibration (see section 5.2).</p>
Reset Calibration Values	Enter this menu to reset the sensor calibration back to factory defaults.
Cal Required Alarm	To get an alarm message as a reminder to calibrate the sensor on a regular schedule, enter the number of days between calibrations. Set it to 0 if no reminders are necessary.
Alarm & Datalog Suppression	If any of the relays or digital inputs are selected, any alarms related to this input will be suppressed if the selected relay or digital input is active. At the same time, all datalogs and graphs containing the input will show no data for the duration of the activation.
Smoothing Factor	Increase the smoothing factor percentage to dampen the response to changes. For example, with a 10% smoothing factor, the next reading shown will consist of an average of 10% of the previous value and 90% of the current value.
Stabilization Time	The sensor needs some time to warm up on power-up. Enter the time delay on start-up before the sensor signal is valid.
Units	Select the units of measure for the copper/nickel (g/l or oz./gal).
Name	The name used to identify the sensor may be changed.
Type	Select the type of sensor to be connected.

5.2.2 Contacting Conductivity

Settings

Touch the Settings icon to view or change the settings related to the sensor.

Alarms	Low-Low, Low, High and High-High Alarms limits may be set.
Deadband	This is the Alarm Deadband. For example, if the High Alarm is 3000, and the deadband is 10, the alarm will activate at 3001 and deactivate at 2990.
Reset Calibration Values	Enter this menu to reset the sensor calibration back to factory defaults.
Cal Required Alarm	To get an alarm message as a reminder to calibrate the sensor on a regular schedule, enter the number of days between calibrations. Set it to 0 if no reminders are necessary.
Alarm & Datalog Suppression	If any of the relays or digital inputs are selected, any alarms related to this input will be suppressed if the selected relay or digital input is active. At the same time, all datalogs and graphs containing the input will show no data for the duration of the activation.
Smoothing Factor	Increase the smoothing factor percentage to dampen the response to changes. For example, with a 10% smoothing factor, the next reading shown will consist of an average of 10% of the previous value and 90% of the current value.

Default Temp	If the temperature signal is lost at any time, then the controller will use the Default Temp setting for temperature compensation.
Cable Length	The controller automatically compensates for errors in the reading caused by varying the length of the cable.
Gauge	The cable length compensation depends upon the gauge of wire used to extend the cable
Cell Constant	Do not change unless instructed by the factory.
Temp Compensation	Select between the standard NaCl temperature compensation method or a linear %/degree C method.
Temp Comp Factor	This menu only appears if Linear Temp Comp is selected. Change the %/degree C to match the chemistry being measured. Standard water is 2%.
Units	Select the units of measure for the conductivity.
Name	The name used to identify the sensor may be changed.
Type	Select the type of sensor to be connected.

5.2.3 Electrodeless Conductivity

Settings

Touch the Settings icon to view or change the settings related to the sensor.

Alarms	Low-Low, Low, High and High-High Alarms limits may be set.
Deadband	This is the Alarm Deadband. For example, if the High Alarm is 3000, and the deadband is 10, the alarm will activate at 3000 and deactivate at 2990.
Reset Calibration Values	Enter this menu to reset the sensor calibration back to factory defaults.
Cal Required Alarm	To get an alarm message as a reminder to calibrate the sensor on a regular schedule, enter the number of days between calibrations. Set it to 0 if no reminders are necessary.
Alarm & Datalog Suppression	If any of the relays or digital inputs are selected, any alarms related to this input will be suppressed if the selected relay or digital input is active. At the same time, all datalogs and graphs containing the input will show no data for the duration of the activation.
Smoothing Factor	Increase the smoothing factor percentage to dampen the response to changes. For example, with a 10% smoothing factor, the next reading shown will consist of an average of 10% of the previous value and 90% of the current value.
Default Temp	If the temperature signal is lost at any time, then the controller will use the Default Temp setting for temperature compensation.
Installation Factor	Do not change unless instructed by the factory.
Cable Length	The controller automatically compensates for errors in the reading caused by varying the length of the cable.
Gauge	The cable length compensation depends upon the gauge of wire used to extend the cable
Cell Constant	Do not change unless instructed by the factory.
Range	Select the range of conductivity that best matches the conditions the sensor will see.
Temp Compensation	Select between the standard NaCl temperature compensation method or a linear %/degree C method.
Temp Comp Factor	This menu only appears if Linear Temp Comp is selected. Change the %/degree C to match the chemistry being measured. Standard water is 2%.
Units	Select the units of measure for the conductivity.
Name	The name used to identify the sensor may be changed.
Type	Select the type of sensor to be connected.

5.2.4 Temperature

Settings

Touch the Settings icon to view or change the settings related to the sensor.

Alarms	Low-Low, Low, High and High-High Alarms limits may be set.
Deadband	This is the Alarm Deadband. For example, if the High Alarm is 100, and the deadband is 1, the alarm will activate at 100 and deactivate at 99.
Reset Calibration Values	Enter this menu to reset the sensor calibration back to factory defaults.
Cal Required Alarm	To get an alarm message as a reminder to calibrate the sensor on a regular schedule, enter the number of days between calibrations. Set it to 0 if no reminders are necessary.
Alarm & Datalog Suppression	If any of the relays or digital inputs are selected, any alarms related to this input will be suppressed if the selected relay or digital input is active. At the same time, all datalogs and graphs containing the input will show no data for the duration of the activation.
Smoothing Factor	Increase the smoothing factor percentage to dampen the response to changes. For example, with a 10% smoothing factor, the next reading shown will consist of an average of 10% of the previous value and 90% of the current value.
Name	The name used to identify the sensor may be changed.
Element	Select the specific type of temperature sensor to be connected.

5.2.5 pH

Settings

Touch the Settings icon to view or change the settings related to the sensor.

Alarms	Low-Low, Low, High and High-High Alarms limits may be set.
Deadband	This is the Alarm Deadband. For example, if the High Alarm is 9.50, and the deadband is 0.05, the alarm will activate at 9.51 and deactivate at 9.45.
Alarm & Datalog Suppression	If any of the relays or digital inputs are selected, any alarms related to this input will be suppressed if the selected relay or digital input is active. At the same time, all datalogs and graphs containing the input will show no data for the duration of the activation.
Smoothing Factor	Increase the smoothing factor percentage to dampen the response to changes. For example, with a 10% smoothing factor, the next reading shown will consist of an average of 10% of the previous value and 90% of the current value.
Reset Calibration Values	Enter this menu to reset the sensor calibration back to factory defaults.
Cal Required Alarm	To get an alarm message as a reminder to calibrate the sensor on a regular schedule, enter the number of days between calibrations. Set it to 0 if no reminders are necessary.
Buffers	Select if calibration buffers will be manually entered, or if they will be automatically detected, and if so, which set of buffers will be used. The choices are Manual Entry, JIS/NIST Standard, DIN Technical, or Traceable 4/7/10.
Default Temp	If the temperature signal is lost at any time, then the controller will use the Default Temp setting for temperature compensation.
Cable Length	The controller automatically compensates for errors in the reading caused by varying the length of the cable.
Gauge	The cable length compensation depends upon the gauge of wire used to extend the cable
Electrode	Select Glass for a standard pH electrode, or Antimony. Antimony pH electrodes have a default slope of 49 mV/pH and an offset of -320 mV at pH 7.
Name	The name used to identify the sensor may be changed.

Type	Select the type of sensor to be connected.
-------------	--

5.2.6 ORP

Settings

Touch the Settings icon to view or change the settings related to the sensor.

Alarms	Low-Low, Low, High and High-High Alarms limits may be set.
Deadband	This is the Alarm Deadband. For example, if the High Alarm is 800, and the deadband is 10, the alarm will activate at 801 and deactivate at 790.
Reset Calibration Values	Enter this menu to reset the sensor calibration back to factory defaults.
Cal Required Alarm	To get an alarm message as a reminder to calibrate the sensor on a regular schedule, enter the number of days between calibrations. Set it to 0 if no reminders are necessary.
Alarm & Datalog Suppression	If any of the relays or digital inputs are selected, any alarms related to this input will be suppressed if the selected relay or digital input is active. At the same time, all datalogs and graphs containing the input will show no data for the duration of the activation.
Smoothing Factor	Increase the smoothing factor percentage to dampen the response to changes. For example, with a 10% smoothing factor, the next reading shown will consist of an average of 10% of the previous value and 90% of the current value.
Cable Length	The controller automatically compensates for errors in the reading caused by varying the length of the cable.
Gauge	The cable length compensation depends upon the gauge of wire used to extend the cable
Name	The name used to identify the sensor may be changed.
Type	Select the type of sensor to be connected.

5.2.7 Disinfection

Settings

Touch the Settings icon to view or change the settings related to the sensor.

Alarms	Low-Low, Low, High and High-High Alarms limits may be set.
Deadband	This is the Alarm Deadband. For example, if the High Alarm is 7.00, and the deadband is 0.1, the alarm will activate at 7.01 and deactivate at 6.90.
Reset Calibration Values	Enter this menu to reset the sensor calibration back to factory defaults.
Cal Required Alarm	To get an alarm message as a reminder to calibrate the sensor on a regular schedule, enter the number of days between calibrations. Set it to 0 if no reminders are necessary.
Alarm & Datalog Suppression	If any of the relays or digital inputs are selected, any alarms related to this input will be suppressed if the selected relay or digital input is active. At the same time, all datalogs and graphs containing the input will show no data for the duration of the activation.
Smoothing Factor	Increase the smoothing factor percentage to dampen the response to changes. For example, with a 10% smoothing factor, the next reading shown will consist of an average of 10% of the previous value and 90% of the current value.
Cable Length	The controller automatically compensates for errors in the reading caused by varying the length of the cable.
Gauge	The cable length compensation depends upon the gauge of wire used to extend the cable
Name	The name used to identify the sensor may be changed.
Sensor	Select the specific type and range of disinfection sensor to be connected.

Type	Select the type of sensor to be connected.
------	--

5.2.8 Generic Sensor

Settings

Touch the Settings icon to view or change the settings related to the sensor.

Alarms	Low-Low, Low, High and High-High Alarms limits may be set.
Deadband	This is the Alarm Deadband. For example, if the High Alarm is 7.00, and the deadband is 0.1, the alarm will activate at 7.01 and deactivate at 6.90.
Reset Calibration Values	Enter this menu to reset the sensor calibration back to factory defaults.
Cal Required Alarm	To get an alarm message as a reminder to calibrate the sensor on a regular schedule, enter the number of days between calibrations. Set it to 0 if no reminders are necessary.
Alarm & Datalog Suppression	If any of the relays or digital inputs are selected, any alarms related to this input will be suppressed if the selected relay or digital input is active. At the same time, all datalogs and graphs containing the input will show no data for the duration of the activation.
Sensor Slope	Enter the slope of sensor in mV/Units (if Electrode selection is Linear) or mV/Decade (if Electrode selection is Ion Selective).
Sensor Offset	Only appears if the Electrode selection is Linear. Enter the offset of the sensor in mV if 0 mV is not equal to 0 units. For Ion Selective Electrodes, the Sensor Offset is not calculated until the first calibration is performed, and the sensor will read Zero until a calibration has been successfully completed!
Low Range	Enter the low end of the range of the sensor
High Range	Enter the high end of the range of the sensor
Smoothing Factor	Increase the smoothing factor percentage to dampen the response to changes. For example, with a 10% smoothing factor, the next reading shown will consist of an average of 10% of the previous value and 90% of the current value.
Cable Length	The controller automatically compensates for errors in the reading caused by varying the length of the cable.
Gauge	The cable length compensation depends upon the gauge of wire used to extend the cable
Units	Type in the units of measure for the input, for example, ppm.
Electrode	Select the type of electrode to be connected. Select Linear if the sensor slope is a linear voltage per Units. Select Ion Selective if the electrode voltage output is logarithmic, defined as “mV/decade”.
Name	The name used to identify the sensor may be changed.
Type	Select the type of sensor to be connected.

5.2.9 Transmitter Input and AI Monitor Input

Select AI monitor if the device connected can be calibrated on its own and the W600 calibration will only be in units of mA. Select Transmitter if the device connected cannot be calibrated on its own and the W600 will be used to calibrate in engineering units of measure.

Settings

Touch the Settings icon to view or change the settings related to the sensor.

Alarms	Low-Low, Low, High and High-High Alarms limits may be set.
Deadband	This is the Alarm Deadband. For example, if the High Alarm is 7.00, and the deadband is 0.1, the alarm will activate at 7.01 and deactivate at 6.90.
Reset Calibration Values	Enter this menu to reset the sensor calibration back to factory defaults.

Cal Required Alarm	To get an alarm message as a reminder to calibrate the sensor on a regular schedule, enter the number of days between calibrations. Set it to 0 if no reminders are necessary.
Alarm & Datalog Suppression	If any of the relays or digital inputs are selected, any alarms related to this input will be suppressed if the selected relay or digital input is active. At the same time, all datalogs and graphs containing the input will show no data for the duration of the activation.
Smoothing Factor	Increase the smoothing factor percentage to dampen the response to changes. For example, with a 10% smoothing factor, the next reading shown will consist of an average of 10% of the previous value and 90% of the current value.
4 mA Value	Enter the value that corresponds to a 4 mA output signal from the transmitter.
20 mA Value	Enter the value that corresponds to a 20 mA output signal from the transmitter.
Units	Select the units of measure for the transmitter.
Name	The name used to identify the transmitter may be changed.
Type	Select the type of sensor to be connected. The choice of AI Monitor and Transmitter is only available if a 4-20mA type sensor card is installed.

5.2.10 Fluorometer Input

Settings 

Touch the Settings icon to view or change the settings related to the sensor.

Alarms	Low-Low, Low, High and High-High Alarms limits may be set.
Deadband	This is the Alarm Deadband. For example, if the High Alarm is 7.00, and the deadband is 0.1, the alarm will activate at 7.01 and deactivate at 6.90.
Reset Calibration Values	Enter this menu to reset the sensor calibration back to factory defaults.
Cal Required Alarm	To get an alarm message as a reminder to calibrate the sensor on a regular schedule, enter the number of days between calibrations. Set it to 0 if no reminders are necessary.
Alarm & Datalog Suppression	If any of the relays or digital inputs are selected, any alarms related to this input will be suppressed if the selected relay or digital input is active. At the same time, all datalogs and graphs containing the input will show no data for the duration of the activation.
Smoothing Factor	Increase the smoothing factor percentage to dampen the response to changes. For example, with a 10% smoothing factor, the next reading shown will consist of an average of 10% of the previous value and 90% of the current value.
Max Sensor Range	Enter the value of the ppb of dye at which the sensor transmits 20 mA.
Dye/Product Ratio	Enter the value for the ratio of ppb of dye to ppm of inhibitor that is in the inhibitor product being fed.
Name	The name used to identify the transmitter may be changed.
Type	Select the type of sensor to be connected. The choice of Analog Input is only available if that type of sensor card is installed.

5.2.11 Analog Flowmeter Input

Settings 

Touch the Edit icon to view or change the settings related to the sensor.

Alarms	Low-Low, Low, High and High-High Alarms limits may be set.
Deadband	This is the Alarm Deadband. For example, if the High Alarm is 7.00, and the deadband is 0.1, the alarm will activate at 7.01 and deactivate at 6.90.
Totalizer Alarm	Enter the high limit on the total volume of water accumulated above which an alarm will be activated.

Reset Flow Total	Enter this menu to reset the accumulated flow total to 0. Touch Confirm to accept, Cancel to leave the total at the previous value and go back.
Set Flow Total	This menu is used to set the total volume stored in the controller to match the register on the flow meter. Enter the desired value.
Scheduled Reset	Choose to automatically reset the flow total, and if so, Daily, Monthly or Annually.
Reset Calibration Values	Enter this menu to reset the sensor calibration back to factory defaults.
Cal Required Alarm	To get an alarm message as a reminder to calibrate the sensor on a regular schedule, enter the number of days between calibrations. Set it to 0 if no reminders are necessary.
Alarm & Datalog Suppression	If any of the relays or digital inputs are selected, any alarms related to this input will be suppressed if the selected relay or digital input is active. At the same time, all datalogs and graphs containing the input will show no data for the duration of the activation.
Smoothing Factor	Increase the smoothing factor percentage to dampen the response to changes. For example, with a 10% smoothing factor, the next reading shown will consist of an average of 10% of the previous value and 90% of the current value.
Transmitter	Select the type of transmitter connected (2-wire loop powered, 2-wire self-powered, 3-wire, or 4-wire).
Flow Units	Select the units of measure for the water volume, between gallons, liters, cubic meters and million of gallons (MG).
Rate Units	Select the units of measure for the flow rate time base.
Flowmeter Max	Enter the flow rate at which the meter outputs a 20 mA signal.
Input Filter	Enter the mA below which the flow rate will be considered 0. Typically any meter output below 4.02 mA is actually 0 flow.
Name	The name used to identify the sensor may be changed.
Type	Select the type of sensor to be connected.

5.2.12 DI State

Input Details

The details for this type of input include the current state with a custom message for open versus closed, alarms, the status of the interlock, and the current type of input setting.

Settings

Touch the Settings icon to view or change the settings related to the sensor.

Open Message	The words used to describe the switch state may be customized.
Closed Message	The words used to describe the switch state may be customized.
Interlock	Choose whether the input should be in the interlocked state when the switch is either open or closed.
Alarm	Choose if an alarm should be generated when the switch is open, or closed, or if no alarm should ever be generated.
Alarm & Datalog Suppression	If any of the relays or digital inputs are selected, any alarms related to this input will be suppressed if the selected relay or digital input is active. At the same time, all datalogs and graphs containing the input will show no data for the duration of the activation.
Total Time	Choose to totalize the amount of time that the switch has been open or closed. This will be displayed on the input details screen.
Reset Total Time	Enter this menu to reset the accumulated time to zero. Touch Confirm to accept, Cancel to leave the total at the previous value and go back.
Name	The name used to identify the switch may be changed.
Type	Select the type of sensor to be connected to the digital input channel.

5.2.13 Flow Meter, Contactor Type

Input Details

The details for this type of input include the total volume accumulated through the flow meter, alarms, and the current type of input setting.

Settings

Touch the Settings icon to view or change the settings related to the sensor.

Totalizer Alarm	A high limit on the total volume of water accumulated may be set.
Alarm & Datalog Suppression	If any of the relays or digital inputs are selected, any alarms related to this input will be suppressed if the selected relay or digital input is active. At the same time, all datalogs and graphs containing the input will show no data for the duration of the activation.
Reset Flow Total	Enter this menu to reset the accumulated flow total to 0. Touch Confirm to accept, Cancel to leave the total at the previous value and go back.
Set Flow Total	This menu is used to set the total volume stored in the controller to match the register on the flow meter. Enter the desired value.
Scheduled Reset	Choose to automatically reset the flow total, and if so, Daily, Monthly or Annually.
Volume/Contact	Enter the volume of water that needs to go through the flow meter in order to generate a contact closure.
Flow Units	Select the units of measure for the water volume.
Name	The name used to identify the sensor may be changed.
Type	Select the type of sensor to be connected to the digital input channel.

5.2.14 Flow Meter, Paddlewheel Type

Input Details

The details for this type of input include the current flow rate, total volume accumulated through the flow meter, alarms, and the current type of input setting.

Settings

Touch the Settings icon to view or change the settings related to the sensor.

Alarms	Low and High Alarm limits may be set.
Alarm & Datalog Suppression	If any of the relays or digital inputs are selected, any alarms related to this input will be suppressed if the selected relay or digital input is active. At the same time, all datalogs and graphs containing the input will show no data for the duration of the activation.
Deadband	This is the Alarm Deadband. For example, if the High Alarm is 100, and the deadband is 1, the alarm will activate at 100 and deactivate at 99.
Totalizer Alarm	A high limit on the total volume of water accumulated may be set.
Reset Flow Total	Enter this menu to reset the accumulated flow total to 0. Touch Confirm to accept, Cancel to leave the total at the previous value and go back.
Set Flow Total	This menu is used to set the total volume stored in the controller to match the register on the flow meter. Enter the desired value.
Scheduled Reset	Choose to automatically reset the flow total, and if so, Daily, Monthly or Annually.
K Factor	Enter the pulses generated by the paddlewheel per unit volume of water.
Flow Units	Select the units of measure for the water volume.
Rate Units	Select the units of measure for the flow rate time base.

Smoothing Factor	Increase the smoothing factor percentage to dampen the response to changes. For example, with a 10% smoothing factor, the next reading shown will consist of an average of 10% of the previous value and 90% of the current value.
Name	The name used to identify the sensor may be changed.
Type	Select the type of sensor to be connected to the digital input channel.

5.2.15 Feed Monitor

The Feed Monitor Digital Input type performs the following functions:

- Monitors a pulse signal from a pump (Iwaki PosiFlow, Tacmina Flow Checker, LMI Digital Pulse, etc)
- Totalizes the chemical feed and calculates the current flow rate
- Activates a Total Alarm if the feed exceeds a specified limit
- Activates a Flow verify alarm if the control output is ON and the feed monitor does not record any pulses within a specified period of time.

Each Feed Monitor input can be linked to any type of output channel (powered relay, dry contact relay, solid state relay, or analog 4-20 mA) to validate chemical feed from any type of pump.

Total Alarm

The W600 monitors the total feed and activates a Total Alarm if the value exceeds the Totalizer Alarm set point. When used in conjunction with Scheduled Reset selections (Daily, Monthly, or Annually), this alarm can be used to alert users to situations where excess chemical product is used and/or to discontinue chemical feed if the amount exceeds the set point during the specified time period.

While a Total Alarm is active, the linked pump will be controlled based on the Total Alarm Mode setting:

Interlock	The output will be OFF while the alarm is active.
Maintain	The alarm condition has no effect on output control.

Flow Verify Alarm

The W600 monitors the status or current percent output of the channel linked to the feed monitor to determine if a Flow Verify alarm should be activated.

The *Flow Alarm Delay* setting (MM:SS) contains the time to trigger the alarm if the output is activated and no pulses are registered. To avoid nuisance alarms at very low flow rates, if the linked output is a solid state relay (set with a pulse proportional or PID control mode) or an analog 4-20 mA output, the alarm will only be activated if no input pulses are monitored while the output is set to greater than a specified Dead Band (%).

The *Flow Alarm Clear* setting is the number of pulses that must be registered to verify that pump operation is restored and clear the Flow Verify alarm. During Flow Verify alarm conditions, the count of pulses registered will be reset to zero if no single pulses occur during the Flow Alarm Delay time period. In this manner, random single pulses spread over a long time period will not accumulate and result in a Flow Verify alarm being cleared before product feed is actually restored.

If desired, a user can configure the feed monitor to attempt to reprime the pump when a Flow Verify alarm first is activated.

The *Reprime Time* (MM:SS) specifies the amount of time that the output should be energized after the initiation of a Flow Verify alarm. If the linked output is a solid state relay (set to a pulse proportional or PID control mode) or an analog 4-20 mA output, the output will be set to the Max Output percent during the reprime event. If the Flow Verify alarm is cleared during the reprime event (because the specified number of pulses was registered), the reprime event will be immediately ended and normal control of the output channel will be restored.

While a Flow Verify alarm is active, the linked pump will be controlled based on the Flow Alarm Mode setting:

Disabled	<i>Flow Verify</i> alarms are not monitored, no change in output control.
Interlock	The output will be forced OFF while the alarm is active.(except during the reprime event)
Maintain	The alarm condition has no effect on output control. (except during the reprime event)

If a *Flow Verify* alarm is active and *Interlock* is selected, the output to the pump will be turned off after the specified Reprime Time and only operator actions can restore normal control operations. In most cases, action will be taken to manually reprime the pump, refill the chemical tank, etc. and the output will be put into Hand mode to confirm proper operation of the pump. When the Feed Monitor registers sufficient pulses, the Flow Verify alarm will clear and the pump output can be put back into Auto Mode.

If both *Total Alarm* and *Flow Verify* alarms are active simultaneously, an Interlock selection for either mode setting will take precedence for pump control. Automatic output control will continue despite the alarm conditions only if Maintain is selected for both mode settings.

Interlocking or Activating any Control Output with a Feed Monitor Input

Digital Input channels are available for selection as Interlock Channels or Activate With Channels by any output. If a Feed Monitor is selected in this manner, the Digital Input will trigger that action if any alarm (Flow Verify, Total Alarm, or Range Alarm) is currently active.

Input Details

The details for this type of input include the current flow rate of chemical feed, the total volume fed since the last reset, alarms, the status of the output linked to the input, the date and time of the last total reset, and the current type of input setting.

Settings

Touch the Settings icon to view or change the settings related to the sensor.

Totalizer Alarm	A high limit on the total accumulated volume of chemical fed may be set, to trigger a Total Alarm.
Reset Flow Total	Enter this menu to reset the accumulated flow total to 0. Touch Confirm to accept, Cancel to leave the total at the previous value and go back.
Set Flow Total	This menu is used to set the total accumulated volume stored in the controller to match a specified volume.
Scheduled Reset	Choose to automatically reset the flow total, and if so, Daily, Monthly or Annually
Total Alarm Mode	Choose to Interlock or Maintain the control of the linked pump while the Total Alarm is active.
Flow Alarm Mode	Choose to Interlock or Maintain the control of the linked pump while a Flow Verify alarm is active. Choose Disable to monitor flow rate and accumulate total without any flow alarms.
Flow Alarm Delay	Time (MM:SS) that will trigger a Flow Verify alarm if the output is activated and no pulses are registered.
Flow Alarm Clear	Enter the number of contacts that must be registered to clear a Flow Verify alarm.
Dead band	Enter the percent output above which the pump is considered On for monitoring of Flow Verify alarms. This setting is only available if the linked Output is a solid state (pulsing) relay or analog (4-20 mA) output.
Reprime Time	Time (MM:SS) that the output should be energized for the reprime event.
Volume/Contact	Enter the volume, in ml, of chemical delivered for each pulse of the feed monitoring device.
Flow Units	Select the units of measure for the accumulated feed total.
Rate Units	Select the units of measure for the feed flow rate time base.
Smoothing Factor	Increase the smoothing factor percentage to dampen the response to changes in the flowrate. For example, with a 10% smoothing factor, the next reading shown will consist of an average of 10% of the previous value and 90% of the current value.
Output	Select the relay or analog (4-20 mA) output channel controlling the pump which will be monitored by this feed monitor input.

Name	The name used to identify the sensor may be changed.
Type	Select the type of sensor to be connected to the digital input channel

5.2.16 DI Counter Input

ONLY AVAILABLE IF HVAC MODES ARE DISABLED IN CONFIG MENU – GLOBAL SETTINGS

A digital input counter input is used to count contacts from a digital input, totalize the number of contacts, and monitor or control on the rate of contacts.

Input Details

The details for this type of input include the current rate, total contacts counted (in user defined units), date and time of last total reset, alarms, and the current type of input setting.

Settings

Touch the Settings icon to view or change the settings related to the virtual input.

Alarms	Low and High Alarm limits may be set.
Deadband	This is the Alarm Deadband. For example, if the High Alarm is 100, and the deadband is 1, the alarm will activate at 100 and deactivate at 99
Totalizer Alarm	A high limit on the total number of contact closures accumulated may be set.
Alarm & Datalog Suppression	If any of the relays or digital inputs are selected, any alarms related to this input will be suppressed if the selected relay or digital input is active. At the same time, all datalogs and graphs containing the input will show no data for the duration of the activation.
Reset Total	Enter this menu to reset the accumulated total to 0. Touch Confirm to accept, or Cancel to leave the total at the previous value and go back.
Set Total	This menu is used to set the total number of contact closures stored in the controller a certain value.
Scheduled Reset	Choose to automatically reset the flow total, and if so, Daily, Monthly or Annually.
Units	Type in the units of measure for the what the contacts represent (widgets, etc.)
Rate Units	Select the units of measure for the rate time base (widgets per second, minute, hour, day).
Units per Pulse	Enter the number of units represented by one pulse.
Smoothing Factor	Increase the smoothing factor percentage to dampen the response to changes. For example, with a 10% smoothing factor, the next rate reading shown will consist of an average of 10% of the previous value and 90% of the current value.
Name	The name used to identify the sensor may be changed.
Type	Select the type of sensor to be connected to the digital input channel.

5.2.17 Virtual Input – Calculation

A Virtual Input is not a physical sensor; it is a value that is calculated from two physical sensor inputs. The analog values that can be used for each type of calculation are selected from a List of all defined sensor inputs, analog inputs, flowmeter rates, the other virtual input, solid state relay %, and analog output %.

Calculation modes are:

- **Difference** (Input - Input 2)
- **Ratio** (Input / Input 2)
 - This selection could be used to calculate Cycles of Concentration in HVAC applications, for example

- **Total** (Input + Input 2)
- **% Difference** [(Input - Input 2) / Input]
 - This selection could be used to calculate % Rejection in RO applications, for example

Virtual Input Details

The details for any type of virtual input include the current value calculated, alarms, the status, and the input type.

Settings

Touch the Settings icon to view or change the settings related to the virtual input.

Alarms	Low-Low, Low, High and High-High Alarms limits may be set.
Deadband	This is the Alarm Deadband. For example, if the High Alarm is 7.00, and the deadband is 0.1, the alarm will activate at 7.01 and deactivate at 6.90.
Input	Select the physical input whose value will be used in the calculation shown above as the Input in the formula.
Input 2	Select the physical input whose value will be used in the calculation shown above as the Input 2 in the formula.
Calculation Mode	Select a calculation mode from the list.
Alarm & Datalog Suppression	If any of the relays or digital inputs are selected, any alarms related to this input will be suppressed if the selected relay or digital input is active. At the same time, all datalogs and graphs containing the input will show no data for the duration of the activation.
Low Range	Set the low end of the normal range for the calculated value. A value below this will trigger a Range Alarm and deactivate any control output using the virtual input.
High Range	Set the high end of the normal range for the calculated value. A value above this will trigger a Range Alarm and deactivate any control output using the virtual input.
Smoothing Factor	Increase the smoothing factor percentage to dampen the response to changes. For example, with a 10% smoothing factor, the next reading shown will consist of an average of 10% of the previous value and 90% of the current value.
Name	The name used to identify the input may be changed.
Type	Select the type of input; either Calculation or Not Used.

5.2.18 Virtual Input – Redundant

A Redundant type Virtual Input is not a physical sensor; it is a value that is calculated from two physical sensor inputs. The redundant sensor algorithm compares the readings from two sensors, and chooses which sensor to use. The value of the virtual input is the value of the sensor chosen by this comparison.

If the difference between the two exceeds a programmable amount, a deviation alarm is set, but control continues. If one of the sensors goes into a range error or a fault alarm, the other sensor will take over. If both sensors give invalid readings, an input alarm is set and any outputs using the virtual input for control are disabled.

The analog values that can be used for each type of calculation are selected from a List of all defined sensor inputs and analog inputs.

There are three modes:

- **Primary/Backup** – The primary sensor (selected as the Input) value, as opposed to the backup sensor (selected as Input 2) value, is chosen as the virtual input value, assuming it has a valid reading.
- **Minimum Value** – The sensor that has the lower reading of the two sensors is chosen as the virtual

- input value. This makes sense if a failing sensor normally drifts high.
- **Maximum Value** – The sensor that has the higher reading of the two sensors is chosen as the virtual input value. This makes sense if a failing sensor normally drifts low.

Virtual Input Details

The details for a virtual input include the current difference calculated, the current values of the inputs used in the calculation, alarms, the status, and the input type.

Settings

Touch the Edit icon to view or change the settings related to the virtual input.

Deviation Alarm	Enter the value for the difference between the two input readings above which the deviation alarm will trigger.
Deadband	This is the Alarm Deadband. For example, if the Deviation Alarm is 1.00, and the deadband is 0.1, the alarm will activate if the sensor readings are 1.01 units apart, and deactivate at 0.89 units apart.
Alarm & Datalog Suppression	If any of the relays or digital inputs are selected, any alarms related to this input will be suppressed if the selected relay or digital input is active. At the same time, all datalogs and graphs containing the input will show no data for the duration of the activation.
Mode	Select which mode for determining the value for the virtual sensor input.
Input	Select the physical input for the primary sensor.
Input 2	Select the physical input for the backup sensor.
Name	The name used to identify the input may be changed.
Type	Select the type of input; either Calculation, Redundant, Raw Value, Disturbance, or Not Used.

5.2.19 Virtual Input – Raw Value

A Raw Value type Virtual Input is not a normal sensor signal. The value of the virtual input comes from the unmanipulated signal from a real sensor.

- non-temperature compensated $\mu\text{S}/\text{cm}$
- mV for pH, ORP, Disinfection
- mA for analog inputs
- ohms for temperature

Virtual Input Details

The details for a virtual input include the current raw value of the real input used, alarms, the status, and the input type.

Settings

Touch the Settings icon to view or change the settings related to the virtual input.

Alarms	Low-Low, Low, High and High-High Alarms limits may be set.
Deadband	This is the Alarm Deadband. For example, if the High Alarm is 7.00, and the deadband is 0.1, the alarm will activate at 7.01 and deactivate at 6.90.
Alarm & Datalog Suppression	If any of the relays or digital inputs are selected, any alarms related to this input will be suppressed if the selected relay or digital input is active. At the same time, all datalogs and graphs containing the input will show no data for the duration of the activation.

Input	Select the physical input whose raw value will be used as this virtual input.
Smoothing Factor	Increase the smoothing factor percentage to dampen the response to changes. For example, with a 10% smoothing factor, the next reading shown will consist of an average of 10% of the previous value and 90% of the current value.
Name	The name used to identify the input may be changed.
Type	Select the type of input; either Calculation, Raw Value, or Not Used



5.3 Outputs Menu

Touch the Outputs icon from the Main Menu to view a list of all relay and analog outputs. The Page Down icon pages down the list of outputs, the Page Up icon pages up the list of outputs, the Main Menu icon brings back the previous screen.

Touch an output to access that output's details and settings.

NOTE: When the output control mode or the input assigned to that output is changed, the output reverts to OFF mode. Once you have changed all settings to match the new mode or sensor, you must put the output into AUTO mode to start control.

5.3.1 Relay, Any Control Mode

Settings

Touch the Settings icon to view or change the settings related to the relay. Settings that are available for any control mode include:

HOA Setting	Select Hand, Off or Auto mode by touching the desired mode.
Output Time Limit	Enter the maximum amount of time that the relay can be continuously activated. Once the time limit is reached, the relay will deactivate until the Reset Output Timeout menu is entered.
Reset Output Timeout	Enter this menu to clear an Output Timeout alarm and allow the relay to control the process again.
Interlock Channels	Select the relays and digital inputs that will interlock this relay, when those other relays are activated in Auto mode. Using Hand or Off to activate relays bypasses the Interlock logic.
Activate With Channels	Select the relays and digital inputs that will activate this relay, when those other relays are activated in Auto mode. Using Hand or Off to activate relays bypasses the Activate With logic.
Minimum Relay Cycle	Enter the number of seconds that will be minimum amount of time that the relay will be in the active or inactive state. Normally this will be set to 0, but if using a motorized ball valve that takes time to open and close, set this high enough that the valve has time to complete its movement.
Hand Time Limit	Enter the amount of time that the relay will activate for when it is in Hand mode.
Reset Time Total	Press the Confirm icon to reset the total accumulated on-time stored for the output back to 0.
Name	The name used to identify the relay may be changed.
Mode	Select the desired control mode for the output.

5.3.2 Relay, On/Off Control Mode

Output Details

The details for this type of output include the relay on/off state, HOA mode or Interlock status, accumulated on-time, alarms related to this output, current cycle on time, relay type and the current control mode setting.

Settings

Touch the Settings icon to view or change the settings related to the relay.

Set point	Enter the sensor process value at which the relay will activate.
Deadband	Enter the sensor process value away from the set point at which the relay will deactivate.
Duty Cycle Period	Using a duty cycle helps to prevent overshooting the set point in applications where the response of the sensor to chemical additions is slow. Specify the amount of time for the cycle, and the percentage of that cycle time that the relay will be active. The relay will be off for the rest of the cycle, even if the set point has not been satisfied. Enter the length of the duty cycle in minutes:seconds in this menu. Set the time to 00:00 if use of a duty cycle is not required.
Duty Cycle	Enter the percentage of the cycle period that the relay will be active. Set the percentage to 100 if use of a duty cycle is not required.
On Delay Time	Enter the delay time for relay activation in hours:minutes:seconds. Set the time to 00:00:00 to immediately activate the relay.
Off Delay Time	Enter the delay time for relay deactivation in hours:minutes:seconds. Set the time to 00:00:00 to immediately deactivate the relay.
Input	Select the sensor to be used by this relay.
Direction	Select the control direction.

5.3.3 Plating Control

Plating Control works like On/Off Control described above, with the exception that it is possible to calculate the volume of chemical fed, or to calculate the number of metal turnovers. For copper control, the control direction is selected as Electroless (force higher, low set point) or Microetch (force lower, high set point).

Output Details

The details for this type of output include the relay on/off state, HOA mode or Interlock status, accumulated on-time, total feed volume or turns (if enabled), alarms related to this output, current value of the assigned input sensor, current cycle on time, relay type and the current control mode setting.

Settings

Touch the Settings icon to view or change the settings related to the relay.

Set point	Enter the sensor process value at which the relay will activate.
Deadband	Enter the sensor process value away from the set point at which the relay will deactivate.
Duty Cycle Period	Using a duty cycle helps to prevent overshooting the set point in applications where the response of the sensor to chemical additions is slow. Specify the amount of time for the cycle, and the percentage of that cycle time that the relay will be active. The relay will be off for the rest of the cycle, even if the set point has not been satisfied. Enter the length of the duty cycle in minutes:seconds in this menu. Set the time to 00:00 if use of a duty cycle is not required.
Duty Cycle	Enter the percentage of the cycle period that the relay will be active. Set the percentage to 100 if use of a duty cycle is not required.
On Delay Time	Enter the delay time for relay activation in hours:minutes:seconds. Set the time to 00:00:00 to immediately activate the relay.
Off Delay Time	Enter the delay time for relay deactivation in hours:minutes:seconds. Set the time to 00:00:00 to immediately deactivate the relay.
Total Mode	Enter this menu to select the method and program feed totalization
Pump Capacity	Only appears for As Volume or As Turns. Enter the maximum feed rate of the pump connected to this relay.
Pump Setting	Only appears for As Volume or As Turns. Enter the stroke length setting for the metering pump, in percent
Turnover Volume	Only appears for As Turns. Enter the volume of chemical replenishment that equals one metal turnover.

Turnover Limit	Only appears for As Turns. Enter the maximum number of turnovers. The controller can activate an alarm when this number has been exceeded.
Set Turnover Value	Only appears for As Turns. Enter the current number of turnovers if you are not starting with a fresh bath (otherwise reset total to zero, see below).
Reset Total	Enter this menu to reset the accumulated time, volume, or metal turnovers, to zero. Touch Confirm to accept, Cancel to leave the total at the previous value and go back.
Input	Select the sensor to be used by this relay.
Control	Select the control direction.

5.3.4 Plating Follow

Plating Follow is commonly used to feed pH adjustment, reducing agent and/or stabilizer in proportion to electroless copper or nickel replenishment. The Plating Follow relay will activate at the same time as the assigned Control relay, for the same amount of time.

Output Details

The details for this type of output include the relay on/off state, HOA mode or Interlock status, accumulated on-time, total feed volume (if enabled), alarms related to this output, relay type and the current control mode setting.

Settings

Touch the Settings icon to view or change the settings related to the relay.

Total Mode	Enter this menu to select the method and program feed totalization
Pump Capacity	Only appears for As Volume. Enter the maximum feed rate of the pump connected to this relay.
Pump Setting	Only appears for As Volume. Enter the stroke length setting for the metering pump, in percent
Reset Total	Enter this menu to reset the accumulated time, or volume, to zero. Touch Confirm to accept, Cancel to leave the total at the previous value and go back.
Control	Select the relay to be used to activate this relay.

5.3.5 Relay, Percent Timer Control Mode

Output Details

The details for this type of output include the relay on/off state, HOA mode or Interlock status, cycle time, accumulated on-time, alarms related to this output, current cycle on time, relay type and the current control mode setting.

Settings

Touch the Settings icon to view or change the settings related to the relay.

Sample Period	Enter the duration of the sample period.
Feed Percentage	Enter the % of the sample period time to use for the feed relay activation time

5.3.6 Relay, Alarm Output Mode

Output Details

The details for this type of output include the relay on/off state, HOA mode or Interlock status, accumulated on-time, alarms related to this output, current cycle on time, relay type and the current control mode setting.

Settings

Touch the Settings icon to view or change the settings related to the relay.

Alarm Mode	Select the alarm conditions that will put the relay into the alarm state: All Alarms Selected Alarms
On Delay Time	Enter the delay time for relay activation in hours:minutes:seconds. Set the time to 00:00:00 to immediately activate the relay.
Off Delay Time	Enter the delay time for relay deactivation in hours:minutes:seconds. Set the time to 00:00:00 to immediately deactivate the relay.
Select Alarms	Scroll through the list of all inputs and outputs, as well as System Alarms and Network (Ethernet) alarms. Touch the parameter to select alarms related to that parameter, then scroll through the list of alarms. Touch each alarm to check the box indicating the alarm is selected. Touch the Confirm icon when finished with that parameter to save the changes. Repeat for each input and output.
Output	Select if the relay will be active when in the alarm state (Normally Open) or if the relay will be active when not in the alarm state (Normally Closed).

5.3.7 Relay, Time Proportional Control Mode

Output Details

The details for this type of output include the relay on/off state, HOA mode or Interlock status, the current % on time calculated for the cycle, the current point in the cycle time, accumulated on-time, alarms related to this output, current cycle on time, relay type and the current control mode setting.

Settings

Touch the Settings icon to view or change the settings related to the relay.

Set point	Enter the sensor process value at which the relay will be off for the entire Sample Period.
Proportional Band	Enter the distance that the sensor process value is away from the set point at which the relay will be on for the entire Sample Period.
Sample Period	Enter the duration of the sample period.
Input	Select the sensor to be used by this relay.
Direction	Select the control direction.

5.3.8 Relay, Manual Mode

Output Details

The details for this type of output include the relay on/off state, HOA mode or Interlock status, accumulated on-time, alarms related to this output, current cycle on time, relay type and the current control mode setting.

Settings

A Manual relay will activate if the HOA mode is Hand, or if it is Activated With another channel.

On Delay Time	Enter the delay time for relay activation in hours:minutes:seconds. Set the time to 00:00:00 to immediately activate the relay.
Off Delay Time	Enter the delay time for relay deactivation in hours:minutes:seconds. Set the time to 00:00:00 to immediately deactivate the relay.

5.3.9 Relay, Pulse Proportional Control Mode

ONLY AVAILABLE IF CONTROLLER INCLUDES PULSE OUTPUT HARDWARE

Output Details

The details for this type of output include the relay pulse rate, HOA mode or Interlock status, accumulated on-time, alarms related to this output, current cycle on time, relay type and the current control mode setting.

Settings

Touch the Settings icon to view or change the settings related to the relay.

Set point	Enter the sensor process value at which the output will pulse at the Minimum Output % set below.
Proportional Band	Enter the distance that the sensor process value is away from the set point beyond which the output will be pulsing at the Maximum Output % set below.
Minimum Output	Enter the lowest possible pulse rate as a percentage of the Maximum Stroke Rate set below (normally 0%).
Maximum Output	Enter the highest possible pulse rate as a percentage of the Maximum Stroke Rate set below.
Maximum Rate	Enter the maximum pulse rate that the metering pump is designed to accept (10 - 2400 pulse/minute range).
Input	Select the sensor to be used by this relay.
Direction	Set the control direction.

5.3.10 Relay, PID Control Mode

ONLY AVAILABLE IF CONTROLLER INCLUDES PULSE OUTPUT HARDWARE & HVAC MODE IS DISABLED

The PID algorithm controls a solid state relay using standard Proportional-Integral-Derivative control logic. The algorithm provides feedback control based on an error value continuously calculated as the difference between a measured process variable and a desired set point. Tuning settings specify the response for proportional (the size of the error), integral (the time that the error has been present), and derivative (the rate of change for the error) parameters. With proper tuning, the PID control algorithm can hold the process value close the set point while minimizing overshoot and undershoot.

Normalized Error

The error value versus set point that is calculated by the controller is normalized and represented as percent of full scale. As a result, tuning parameters entered by the user are not dependent upon the scale of the process variable and the PID response with similar settings will be more consistent even when using different types of sensor inputs. The scale used to normalize the error is dependent upon the type of sensor selected. By default, the full nominal range of the sensor is used. This range is editable by the user if tighter control is desired.

PID Equation Formats

The controller supports two different forms of the PID equation as specified by the Gain Form setting. The two forms require different units for entry of the PID tuning parameters.

Standard

The standard form is more commonly used in industry because its time-based settings for the integral and derivative coefficients are more meaningful. This form is selected by default.

Parameter	Description	Units
K_p	Gain	unitless
T_i	Integral Time	seconds or seconds/repeat
T_d	Derivative Time	seconds

$$Output (\%) = K_p \left[e(t) + \frac{1}{T_i} \int e(t) dt + T_d \frac{de(t)}{dt} \right]$$

Parameter	Description	Units
$e(t)$	Current Error	% of full scale
dt	Delta Time Between Readings	seconds
$de(t)$	Difference Between Current Error & Previous Error	% of full scale

Parallel

The parallel form allows the user to enter all parameters as Gains. In all cases, larger gain values result in faster output response.

Parameter	Description	Units
K_p	Proportional Gain	unitless
K_i	Integral Gain	1/seconds
K_d	Derivative Gain	seconds

$$\text{Output (\%)} = K_p e(t) + K_i \int e(t)dt + K_d \frac{de(t)}{dt}$$

Integral Value Management

To determine the integral component of the PID calculation, the controller software must maintain a running total of the accumulated area under the error curve (Current Integral). The sign of the value added to the accumulated Current Integral during each cycle may be positive or negative based on the current Direction setting as well as the relative values of the current process reading and the set point.

Override Control

The Current Integral accumulates when the output is set to Auto mode. If the controller is switched to Off mode, the value no longer accumulates, but it is not cleared. Therefore, PID control will resume where it left off if the controller is switched from Off back to Auto. Similarly, accumulation of the Control Integral will be suspended if the output is interlocked and resume after the lock-out is removed.

Bumpless Transfer

When the output is switched from Hand to Auto mode, the controller calculates a value for the Current Integral using the current error to generate the same output percent as the Hand Output setting. This calculation does not use the Derivative tuning setting to minimize errors from momentary fluctuations in the input signal. This feature ensures a smooth transition from manual to automatic control with minimal overshoot or undershoot as long as the user sets the Hand Output percentage close to the value that the process is expected to require for optimal control in Auto mode.

Wind-up Suppression

The Current Integral value that is accumulating while the output is set to Auto can become very large or very small if the process value remains on the same side of the set point for a prolonged period of time. However, the controller may not be able to continue to respond if its output is already set to the minimum or maximum limits (0-100% by default). This condition is referred to as Control Wind-Up and can result severe overshoot or undershoot after a prolonged upset has ended.

For example, if the process value remains far below the set point despite a control output being pinned at 100%, the Current Integral will continue to accumulate errors (wind-up). When the process value finally rises to above the set point, negative errors will begin to decrease the Current Integral value. However, the value may remain large enough to keep the output at 100% long after the set point is satisfied. The controller will overshoot the set point and the process value will continue to rise.

To optimize system recovery after wind-up situations, the controller suppresses updates to the Current Integral that would drive the output beyond its minimum or maximum limit. Ideally, the PID parameters will be tuned and the control elements (pump, valves, etc.) will be sized properly so that the output never reaches its minimum or maximum limit during normal control operations. But with this wind-up suppression feature, overshoot will be minimized should that situation occur.

Output Details

The details for this type of output include the pulse rate in %, HOA mode or Interlock status, input value, current integral, current and accumulated on-times, alarms related to this output, relay type, and the current control mode setting.

Set Point	Numeric entry of a process value used as a target for PID control. The default value, units and display format (number of decimal places) used during data entry are defined based on the Input channel setting selected.
Gain	When the Gain Form setting is Standard, this unitless value is multiplied by the total of the proportional, integral, and derivative terms to determine the calculated output percent.
Proportional Gain	When the Gain Form setting is Parallel, this unitless value is multiplied by the normalized error (current process value versus set point) to determine the proportional component of the calculated output percent.
Integral Time	When the Gain Form setting is Standard, this value is divided into the integral of the normalized error (area under the error curve), then multiplied by the Gain to determine the integral component of the calculated output percent.
Integral Gain	When the Gain Form setting is Parallel, this value is multiplied by the integral of the normalized error (area under the error curve) to determine the integral component of the calculated output percent.
Derivative Time	When the Gain Form setting is Standard, this value is multiplied by the change in error between the current reading and the previous reading, then multiplied by the Gain to determine the derivative component of the calculated output percent.
Derivative Gain	When the Gain Form setting is Parallel, this value is multiplied by the change in error between the current reading and the previous reading to determine the derivative component of the calculated output percent.
Reset PID Integral	The PID Integral Value is a running total of the accumulated area under the error curve (Current Integral). When this menu option is selected, this total is set to zero and the PID algorithm is reset to its initial state.
Minimum Output	Enter the lowest possible pulse rate as a percentage of the Maximum Stroke Rate set below (normally 0%).
Maximum Output	Enter the highest possible pulse rate as a percentage of the Maximum Stroke Rate set below.
Maximum Rate	Enter the maximum pulse rate that the metering pump is designed to accept (10 – 2400 pulse/minute range).
Input	Select the sensor to be used by this relay
Direction	Set the control direction. This setting is used to determine the sign of the calculated error (current process value versus set point) and allows flexible control with only positive values for all PID tuning parameters.
Input Minimum	The low end of the sensor input range, used to normalize errors into percent of full scale units. These values are set to the nominal range of the selected input sensor by default.
Input Maximum	The high end of the sensor input range, used to normalize errors into percent of full scale units. These values are set to the nominal range of the selected input sensor by default.
Gain Form	Select the PID Equation Format used to enter tuning parameters.

5.3.11 Relay, Dual Set Point Mode

Output Details

The details for this type of output include the relay on/off state, HOA mode or Interlock status, accumulated on-time, alarms related to this output, current cycle on time, relay type and the current control mode setting.

Settings

Touch the Settings icon to view or change the settings related to the relay.

Set point	Enter the first sensor process value at which the relay will activate.
Set point 2	Enter the second sensor process value at which the relay will activate.
Deadband	Enter the sensor process value away from the set point at which the relay will deactivate.

Duty Cycle Period	Using a duty cycle helps to prevent overshooting the set point in applications where the response of the sensor to chemical additions is slow. Specify the amount of time for the cycle, and the percentage of that cycle time that the relay will be active. The relay will be off for the rest of the cycle, even if the set point has not been satisfied. Enter the length of the duty cycle in minutes:seconds in this menu. Set the time to 00:00 if use of a duty cycle is not required.
Duty Cycle	Enter the percentage of the cycle period that the relay will be active. Set the percentage to 100 if use of a duty cycle is not required.
On Delay Time	Enter the delay time for relay activation in hours:minutes:seconds. Set the time to 00:00:00 to immediately activate the relay.
Off Delay Time	Enter the delay time for relay deactivation in hours:minutes:seconds. Set the time to 00:00:00 to immediately deactivate the relay.
Input	Select the sensor to be used by this relay.
Direction	Select the control direction. In Range will activate the relay when the input reading is between the two set points. Out of Range will activate the relay when the input reading is outside the two set points.

5.3.12 Relay, Timer Control Mode

ONLY AVAILABLE IF HVAC MODES ARE DISABLED IN CONFIG MENU – GLOBAL SETTINGS

Basic Timer Operation

When a timer event triggers the algorithm will activate the relay for the programmed time.

Special Condition Handling

Overlapping timer events

If a second timer event occurs while the first one is still active, the second event will be ignored. An Event Skipped alarm will be set.

Interlock Conditions

Interlocks override the relay control, but do not change the operation of the timer control.

A digital input or output interlock condition does not delay the relay activation. The relay activation duration timer will continue even if the relay is deactivated due to an interlock condition. This will prevent delayed events which can potentially cause problems in they do not occur at the correct time.

“Activate With” Conditions

“Activate with channels” settings override the relay control, but do not change the operation of the timer control. The relay activation duration timer continues counting when the timer relay is forced on, and ends at the expected time (event start time plus duration). If the “activate with” condition continues after the end of the event time, the relay remains activated.

Alarms

An Event Skipped alarm is set when a second timer event occurs while one event is still running.

An Event Skipped alarm is also set when the timer relay never turns on during an event because of an interlock condition.

The alarm is cleared when the relay is next activated for any reason (the next timer event or HAND mode or “activate with” force on condition).

Output Details

The details for this type of output include the relay on/off state, HOA mode or Interlock status, accumulated on-time, alarms related to this output, current cycle on time, relay type and the current control mode setting. The current week number and day of the week is displayed (even if there is no multi-week repetition event programmed). Cycle Time shows the time counting down of the currently active part of the timer cycle.

Interlock Conditions

Interlocks override the relay control, but do not change the operation of the timer control.

A digital input or output interlock condition does not delay the relay activation. The relay activation duration timer will continue even if the relay is deactivated due to an interlock condition. This will prevent delayed events which

can potentially cause problems in they do not occur at the correct time.

“Activate With” Conditions

“Activate with channels” settings override the relay control, but do not change the operation of the timer control. The relay activation duration timer continues counting when the timer relay is forced on, and ends at the expected time (event start time plus duration). If the “activate with” condition continues after the end of the event time, the relay remains activated.

Alarms

An Event Skipped alarm is set when a second timer event occurs while one event is still running.

An Event Skipped alarm is also set when the timer relay never turns on during an event because of an interlock condition.

The alarm is cleared when the relay is next activated for any reason (the next timer event or HAND mode or “activate with” force on condition).

Output Details

The details for this type of output include the relay on/off state, HOA mode or Interlock status, accumulated on-time, alarms related to this output, current cycle on time, relay type and the current control mode setting. The current week number and day of the week is displayed (even if there is no multi-week repetition event programmed). Cycle Time shows the time counting down of the currently active part of the timer cycle.

Settings 

Touch the Settings icon to view or change the settings related to the relay.

Event 1 (through 10)	Enter these menus to program timer events via the menus below:
Repetition	Select the time cycle to repeat the event: Hourly, Daily, 1 Week, 2 Week, 4 Week, or None. An event means that the output is turned on at the same time of day, for the same amount of time, and except for the Daily cycle, on the same day of the week.
Week	Only appears if Repetition is longer than 1 Week. Select the week during which the event will occur.
Day	Only appears if Repetition is longer than Daily. Select the day of the week during which the event will occur.
Events Per Day	Only appears if Repetition is Hourly. Select the number of events per day. The events occur on the Start Time and then evenly spaced throughout the day.
Start Time	Enter the time of day to start the event.
Duration	Enter the amount of time that the relay will be on.
Input	Select the sensor that will be washed.
Input 2	Select the second sensor, if applicable, that will be washed.
Sensor Mode	Select the effect that the probe wash event will have on any control outputs that use the sensor(s) being washed. The options are to either Disable the sensor readings (turn the control output off) or Hold the sensor reading at the last valid sensor reading prior to the start of the probe wash event.
Hold Time	Enter the amount of time needed to hold the sensor reading after the event has finished, in order for the wash solution to be replaced by process solution.

Settings 

Touch the Settings icon to view or change the settings related to the relay.

Event 1 (through 10)	Enter these menus to program timer events via the menus below:
-----------------------------	--

Repetition	Select the time cycle to repeat the event: Hourly, Daily, 1 Week, 2 Week, 4 Week, or None. An event means that the output is turned on at the same time of day, for the same amount of time, and except for the Daily cycle, on the same day of the week.
Week	Only appears if Repetition is longer than 1 Week. Select the week during which the event will occur.
Day	Only appears if Repetition is longer than Daily. Select the day of the week during which the event will occur.
Events Per Day	Only appears if Repetition is Hourly. Select the number of events per day. The events occur on the Start Time and then evenly spaced throughout the day.
Start Time	Enter the time of day to start the event.
Duration	Enter the amount of time that the relay will be on.
Add Last Missed	Select Enabled if the controller should delay start the most recent timer cycle until immediately after an Interlock clears, or Disabled if all events should be skipped if there is an Interlock condition at the time the add was due to start.

5.3.13 Relay, Probe Wash Control Mode

Basic Timer Operation

When a Probe Wash event triggers, the algorithm will activate the relay for the programmed time. The relay will activate a pump or valve to supply a cleaning solution to the sensor or sensors. The output of the selected sensors will either be held or disabled during the cleaning cycle, and for a programmable hold time after the cleaning cycle.

Special Condition Handling

Overlapping timer events

If a second timer event occurs while the first one is still active, the second event will be ignored. An Event Skipped alarm will be set.

5.3.14 Relay, Spike Control Mode

Basic Timer Operation

This algorithm is typically used to provide a baseline amount of chlorine for disinfection, and periodically shocking the system with a larger dose. During normal operation, the relay will be reacting to sensor to maintain a set point within a programmable Deadband, as described in On/Off Control Mode above. When a Spike event triggers, the algorithm will change from the normal set point to the Spike Set Point, and once it reaches that set point, maintains it for the programmed time. Once the time expires, control to the normal set point resumes.

Special Condition Handling

Overlapping timer events

If a second timer event occurs while the first one is still active, the second event will be ignored. An Event Skipped alarm will be set.

Interlock Conditions

Interlocks override the relay control, but do not change the operation of the timer control.

A digital input or output interlock condition does not delay the relay activation. The relay activation duration timer will continue even if the relay is deactivated due to an interlock condition. This will prevent delayed events which can potentially cause problems in they do not occur at the correct time.

“Activate With” Conditions

“Activate with channels” settings override the relay control, but do not change the operation of the timer control. The relay activation duration timer continues counting when the timer relay is forced on, and ends at the expected time (event start time plus duration). If the “activate with” condition continues after the end of the event time, the relay remains activated.

Alarms

An Event Skipped alarm is set when a second timer event occurs while one event is still running.

An Event Skipped alarm is also set when the timer relay never turns on during an event because of an interlock condition.

The alarm is cleared when the relay is next activated for any reason (the next timer event or HAND mode or “activate with” force on condition).

Output Details

The details for this type of output include the relay on/off state, HOA mode or Interlock status, accumulated on-time, current cycle on time, relay type and alarms. The current week number and day of the week is displayed (even if there is no multi-week repetition event programmed). Cycle Time shows the time counting down of the currently active part of the cycle.

Settings

Press the Settings key view or change the settings related to the relay.

Set point	Enter the sensor process value at which the relay will activate.
Spike Set point	Enter the sensor process value at which the relay will activate during the Spike Event time.
Deadband	Enter the sensor process value away from the set point at which the relay will deactivate. The same Deadband is used for the normal Set Point and the Spike Set Point.
Onset Time	The onset time determines when the duration timer starts. If set to zero, the duration time starts immediately. If set higher than that, the controller will not start the duration timer until the spike set point is achieved, or until the onset time is over, whichever comes first.
Duty Cycle Period	Using a duty cycle helps to prevent overshooting the set point in applications where the response of the sensor to chemical additions is slow. Specify the amount of time for the cycle, and the percentage of that cycle time that the relay will be active. The relay will be off for the rest of the cycle, even if the set point has not been satisfied. Enter the length of the Duty Cycle Period in minutes:seconds in this menu. Set the time to 00:00 if use of a duty cycle is not required.
Duty Cycle	Enter the percentage of the cycle period that the relay will be active. Set the percentage to 100 if use of a duty cycle is not required.
Event 1 (through 8)	Enter these menus to program spike events via the menus below:
Repetition	Select the time cycle to repeat the event: Daily, 1 Week, 2 Week, 4 Week, or None. An event means that the output is turned on at the same time of day, for the same amount of time, and except for the Daily cycle, on the same day of the week.
Week	Only appears if Repetition is longer than 1 Week. Select the week during which the event will occur.
Day	Only appears if Repetition is longer than Daily. Select the day of the week during which the event will occur.
Start Time	Enter the time of day to start the event.
Duration	Enter the amount of time that the relay will be on.
Input	Select the sensor to be used by this relay.
Direction	Select the control direction.

5.3.15 Relay Output, Flow Meter Ratio Control Mode

ONLY AVAILABLE IF HVAC MODES ARE ENABLED IN CONFIG MENU – GLOBAL SETTINGS

Flow Meter Ratio Control Mode is typically used in cooling water applications to control the conductivity of the water using volumetric cycles of concentration. The controller measures the volume of makeup water going through one or two water meters, and after a programmable amount, activates the relay to control a programmable volume out through one or two bleed water meters.

Output Details

The details for this type of output include the relay on/off state, HOA mode or Interlock status, Accumulated make-up water total, bleed cycle volume, remaining volume, relay on-time for this cycle, accumulated on-time, alarms related to this output, relay type, and the current control mode setting.

Settings

Touch the Settings icon to view or change the settings related to the relay.

Accumulator Volume	Enter the volume through the makeup water meters that will activate the relay.
Bleed Volume	Enter the volume through the bleed water meters that will deactivate the relay.
Makeup Meter	Select the makeup water meter from the pulldown list.
Makeup Meter 2	Select the makeup water meter from the pulldown list, if applicable, or leave at None.
Bleed Meter	Select the bleed water meter from the pulldown list.
Bleed Meter 2	Select the bleed water meter from the pulldown list, if applicable, or leave at None.

5.3.16 Relay Output, Flow Proportional Mode

ONLY AVAILABLE IF CONTROLLER INCLUDES PULSE OUTPUT HARDWARE

Overview

In Flow Proportional control mode, the controller monitors the rate of flow through an analog or digital flow meter, and continuously adjusts the proportional band to achieve a target PPM level.

The user enters the target PPM and the data necessary to calculate the proportional band (the water flow rate at which the maximum pulse rate will occur) required to maintain the target PPM with that flow rate of water.

$$\% \text{ output} = \frac{\text{Target PPM} \times \text{Water Flow Rate (liter/min or gal/min)}}{\text{Cycles} \times \text{Pump Capacity (liter or gal/hr)} \times \text{Pump Setting (\%)} \times \text{Specific Gravity} \times 166.67}$$

$$\% \text{ output} = \frac{\text{Target PPM} \times \text{Water Flow Rate (m}^3\text{/min)}}{\text{Cycles} \times \text{Pump Capacity (liter/hr)} \times \text{Pump Setting (\%)} \times \text{Specific Gravity} \times 0.16667}$$

Control Operation

If the output is continuously on for longer than the Output Time Limit, then output will deactivate.

Output Details

The details for this type of output include the output %, HOA mode or Interlock status, alarms related to this output, flow input value, current cycle on time, total accumulated on-time, raw pulse rate output, and the current control mode setting.

Settings

Touch the Settings icon to view or change the settings related to the relay.

Target	Enter the desired PPM set point for the product.
Pump Capacity	Enter the maximum flow rate for the metering pump
Pump Setting	Enter the stroke length setting for the metering pump, in percent
Specific Gravity	Enter the specific gravity of the product to be added.
Maximum Rate	Enter the maximum pulse rate that the metering pump is designed to accept (10 - 2400 pulse/minute range).
Hand Output	Enter the output % desired when the output is in Hand mode
Flow Input	Select the flow meter to be used as an input for this control relay

5.3.17 Relay, Counter Timer Control Mode

ONLY AVAILABLE IF HVAC MODES ARE DISABLED IN CONFIG MENU – GLOBAL SETTINGS

The Counter Timer algorithm activates the relay for a programmable amount of time, triggered by the accumulation of a programmable number of contact closures from a Digital Counter type input.

Output Details

The details for this type of output include the relay on/off state, HOA mode or Interlock status, time on, remaining on-time, accumulator total, total relay activation time, alarms related to this output, relay type and the current control mode setting.

Settings

Touch the Settings icon to view or change the settings related to the relay.

Feed Duration	Enter the amount of time for the relay to activate for once the accumulated setpoint number of contact closures has been reached.
Accumulated Setpoint	Enter the number of contact closures required to trigger the relay activation.
Input	Select the input to be used to control this output.

5.3.18 Relay, Dual Switch Control Mode

Dual Switch mode is typically used to fill or empty a tank, using a level switch contact closure to activate the relay when the liquid level is at one extreme and deactivate the relay at the other extreme. It is more versatile than that; the on and off triggers may be any digital input or relay output state.

Note that the Dual Switch control relay will only respond to trigger relay state changes that occur when that relay is in Auto mode, not if the trigger is activated manually using Hand or Off modes.

Output Details

The details for this type of output include the relay on/off state, HOA mode Interlock or delay status, current cycle on time, the total accumulated on-time since the last reset, alarms related to this output, relay type, and the current control mode setting.

Settings

Touch the Settings icon to view or change the settings related to the relay.

On Switch	Select the digital input or output that will trigger the relay to activate.
Activate On	Select the state of the digital input or output that will trigger the relay to activate.
On Delay Time	Enter the delay time for relay activation in hours:minutes:seconds. Set the time to 00:00:00 to immediately activate the relay.
Off Switch	Select the digital input or output that will trigger the relay to de-activate.
Activate Off	Select the state of the digital input or output that will trigger the relay to deactivate.
Off Delay Time	Enter the delay time for relay deactivation in hours:minutes:seconds. Set the time to 00:00:00 to immediately deactivate the relay.

5.3.19 Relay or Analog Output, Lag Control Mode

Overview

The Lead Lag control mode allows a group of outputs to be controlled by a single control algorithm using a variety of configurations. The control mode support backup pumps operation, alternate pump with wear leveling, and the activation of additional outputs after a time delay, or based on alternate set points, or based on digital state changes.

A Lead Lag group consists of a single Lead output and one or more Lag outputs. The Lead output can be set to any control mode. The new Lag control mode can be selected for any number of additional outputs (limited only by the number of outputs available within the controller). A setting for each Lag output allows selection of a Lead output that is used to create an ordered group of Lead Lag relays.

Example: R1 is an On/Off relay, R2 is set for Lag mode with a Lead output of R1. R3 is set as an additional Lag mode relay with a Lead output of R2, thus creating an ordered chain of three relays in the Lead Lag group (R1←R2←R3). After the group is defined, the Lead output (R1) operates with the standard On/Off Control functionality. The last Lag mode relay in the chain (R3) offers various settings that are used to define the desired control operations for the entire Lead Lag group. Selectable Lead Lag control options include backup, wear leveling, and/or activating additional outputs based on various criteria.

Backup Pump Control

By default, Lead Lag groups always provide backup operation if the Lead control mode determines that its output should be energized but it is disabled due to a Flow Verify alarm and/or because the Lead output HOA setting is Off or Hand (not in Auto mode).

Wear Leveling Modes

The order of Lead and Lag output activation can be changed based on configurable wear leveling modes. This option is intended to allow users to manage the usage of primary and secondary pumps within a system. One wear leveling mode selects a different output each time the group is activated. Additional modes vary the activation of the pumps within the group based on the time-on for each output, with the intent to either balance the usage of each pump or to energize the primary output most often and periodically exercise auxiliary pumps to insure proper operation when they are needed.

Output Activation Modes

Depending on the control mode selected for the Lead output, Lag output(s) can be configured for activation of additional outputs based on one or more of the following criteria:

On-time (for example, energize a second relay 10 minutes after the primary relay is turned on)

Control set points (for example, energize a second relay if the pH continues to rise)

Switch change (for example, energize a second pump to maintain a tank level when the low-low level switch opens)

Control Operation

Backup Pump Control

The default control operation for the Lead Lag group is that if a condition exists that prevents one relay from being activated, it is skipped and the next output in the group is turned on instead. This situation may occur if the output is experiencing an active Flow Verify alarm or the output is not in Auto mode. Backup control using a Lag output does not require any additional settings and could be used to create an output for a backup pump to be activated only if the main pump loses prime and/or is taken out of service for maintenance.

Example: A Lead Lag group consisting of R1, R2 & R3 is configured (R1←R2←R3). All three pumps have Posi-Flow monitors wired to inputs D1, D2 & D3, respectively. R1 uses On/Off mode to control caustic feed to maintain a pH set point above 7.0. R1 and R3 pumps are in Auto mode, R2 pump has been taken out of service for maintenance and is currently in HOA Off mode. The process pH falls below 7.0 and R1 is energized. Before the pH rises to satisfy the dead band, the D1 PosiFlow input monitors an error condition and activates a Flow Verify alarm for the R1 pump. The Lead Lag system de-energizes R1 and checks the status of R2. Because R2 is not in service, R3 is energized to maintain caustic feed.

Each digital input channel set up as a Feed Monitor type has a Flow Alarm Mode setting used to specify how the pump output is handled when Flow Verify alarms are identified. Based on this setting, the Lead Lag group responds as follows:

Disabled	The Flow Verify alarm is never activated and the Lead Lag group is not affected by the status of the PosiFlow input.
Interlock	When a Flow Verify alarm is activated, the related output is immediately turned off; if available, other outputs in the Lead Lag group are activated instead.
Maintain	When a Flow Verify alarm is activated, other outputs in the Lead Lag group are activated instead if they are available; if no other outputs are available, or if additional outputs are required due to Output Activation Mode settings, output(s) reporting a Flow Verify alarm may still be activated as a last resort.

Wear Leveling Modes

After the Lead Lag group is defined, additional parameters can be configured within the settings list of the last output in the group. These options optimize the behavior of the Lead Lag functionality. Several different wear leveling options can be selected to control the order in which outputs are activated.

Disabled

The order in which the Lead and Lag outputs turn on does not change automatically. They are always energized in the same order.

Duty Based

The order in which outputs are activated changes every time the Lead output is activated. How long each individual pump has been running is not considered.

Example: When the Lead output, set for On/Off control, drops below the setpoint, R1 is activated. R1 turns off after its deadband is satisfied. The next time the measurement goes below the setpoint, R2 is activated and R1 remains off. After all outputs in the group have been exercised for one feed cycle, the process begins again with the first output (R1).

Time Balanced

Time balanced mode alternates outputs in a manner that equalizes the runtime of all connected pumps. This mode takes into account how long each output in the Lead Lag group has been running (since a manual reset) and selects the output that has the lowest on-time during each cycle. If the output remains energized longer than the specified cycle time, the time-on for each output is recalculated and a different output may be activated to balance the usage of each.

Example: In a two-pump Lead Lag group, time balanced wear leveling is selected with a cycle time of 2 hours. When the Lead control mode (R1) determines the output should be activated, R2 turns on because it has the lowest accumulated on-time. After 2 hours, if the output remains activated, the on-times are re evaluated and R2 turns off and R1 turns on because it now has the least accumulated total on time. The cycle continues until the Lead control mode determines the feed is complete.

Time Unbalanced

This wear leveling mode improves fault-tolerance of the group by varying the wear on each pump by activating each pump for a different percentage of time. In this mode, a primary output is activated most of the time and secondary (auxiliary) output(s) are activated for a smaller percentage of the total output on-time. This strategy can be useful to ensure that a backup pump is exercised sufficiently so that it will be functional when needed, but does not wear at the same rate as the primary pump to minimize the chances of both pumps failing at the same time. When one Lag pump is defined within the Lead Lag group, the Lead pump runs 60% of the time and the Lag pump runs 40%. If more than two (2) pumps are defined for the group, fixed ratios are used to insure all pumps are exercised periodically and wear at different rates, as shown in the chart.

Percent On	Number of Relays				
Relay	2	3	4	5	6
1	60.0%	47.4%	41.5%	38.4%	36.5%
2	40.0%	31.6%	27.7%	25.6%	24.4%
3		21.1%	18.5%	17.1%	16.2%
4			12.3%	11.4%	10.8%
5				7.6%	7.2%
6					4.8%

Output Activation Modes

Depending on the current control mode selection for the Lead output, additional settings may be available within the settings list of the last output in the group to provide additional option(s) to optimize the behavior of the Lead Lag functionality. Several different activation modes can be selected to control the status of additional output(s) based on either elapsed time, alternate setpoints, and/or alternate switch inputs.

Disabled

No action is taken to activate more than one output within the Lead Lag group of outputs. This mode is used when a group of Lead Lag outputs exists only to provide backup in case of a Flow Verify failure on one of the pumps, or if a pump is taken out of service, and/or if only wear leveling is desired.

Time Based

Lag outputs are activated following the Lead output after a user-settable delay. The same delay value is used for all outputs. This menu selection is available only when the Lead output is using On/Off, Dual Setpoint, Spike or Manual control modes.

Example: If the Lead output is set to Manual, this control option could be used to force on the output based on a digital input signal (e.g., level switch). If the level switch remains open for more than the specified delay time, the second output in the Lead Lag group is energized. If another delay time elapses, a third output (if available) is also turned on.

In On/Off, Dual Setpoint, or Spike control modes, additional pump(s) are energized if the process value remains outside the setpoint range for more than the specified delay time.

Example: In a two-output Lead Lag group (R1←R2), the Lead (R1) output, set for Dual Setpoint control, is programmed to energize its output when the D.O. reading is outside the 4.0-4.5 ppb control range with a deadband of 0.1 ppb. Time based output activation is selected with a delay time of 15 minutes. When the D.O. value falls below 4.0 ppb, R1 is activated. After 15 minutes, if the D.O. has not risen to 4.1 ppb or higher, R2 will also be activated. When the process value reaches 4.1 ppb, both outputs are turned off.

Setpoint Based

Each Lag output has its own setpoint(s) and deadband when this option is selected. The setpoints for each output in the Lead Lag group are evaluated individually and outputs are added as needed based on the current process value. Setpoint based activation mode also incorporates time based activation and can also be configured to trigger an additional pump (if available) after a specified delay time. This menu selection is available only when the Lead output is using On/Off or Dual Setpoint control modes.

Example 1: The Lead output (R1) is set for On/Off control of pH with a setpoint of 8.50, a deadband of 0.20 and a “force lower” control direction. The first Lag output (R2) has a setpoint of 9.00 and a deadband of 0.20. The second Lag output (R3) has a setpoint of 9.50 and a deadband of 0.20. The delay time is disabled (set for 0:00 minutes). Wear leveling is disabled. When the pH goes above 8.50, R1 energizes. If the pH proceeds to exceed 9.00, R2 energizes. And if the pH rises above 9.50, R3 energizes. When the pH decreases to below 9.30, R3 goes off. When the pH falls to below 8.80, R2 goes off. And finally, when the pH decreases to below 8.30, R1 is turned off.

Example 2: The same three-pump configuration (R1←R2←R3) as in Example 1 except the delay time is set for 30 minutes. When the pH goes above 8.50, R1 energizes. If 30 minutes passes before the pH exceeds 9.00 or drops below 8.30, R1 remains on and R2 is energized. If the pH then rises above 9.00, the next output in the group, R3, is

energized. If the pH continues to rise and exceeds 9.50, no additional action is possible. When the pH decreases to below 8.80, R3 goes off. When the pH falls to below 8.30, both R1 and R2 are turned off.

This control is very similar to the operation if three (3) separate On/Off control outputs are configured all with the pH as Input and using the setpoints listed above. However, the Lead Lag option improves on this control by incorporating backup pump controls and optional time based activation. If the pH rises above 8.50 when pump R1 has an active Flow Verify alarm or is in HOA Off mode, pump R2 immediately energizes. R3 energizes when the pH goes above 9.00. Although no third pump is available to activate if the pH continues to rise above 9.50, this control system is more fault tolerant than the currently available options.

Switch Based

When using switch based activation mode, each Lag output has an Activate With Channels setting that is used to specify one or more digital input or relay output channels that activates an additional output. Switch based activation mode incorporates time based activation and can also be configured to trigger an additional output (if available) after a specified delay time. This menu selection is available only when the Lead output is using Manual control mode.

Example 1: A lift station includes a tank with a high level switch (D1) and a high-high level switch (D2). Three pumps are configured as a Lead Lag group (R1←R2←R3). The Lead output (R1) is set for Manual control mode with an Activate With Channels selection of D1 (high level switch), R1 will be energized if D1 closes. The first Lag output (R2) has an Activate With Channels selection of D2 (high-high level switch). The last Lag output (R3) has no Activate With Channels selected. All pumps are in HOA Auto mode. The delay time is disabled (set for 0:00 minutes). Wear leveling is disabled. When the high level switch closes, the R1 pump is activated. If the high-high level switch closes, the R2 pump is also activated. When D2 opens, R2 is turned off. When D1 opens, R1 is turned off. In this configuration, the R3 pump serves only as a backup in case one of the pumps is down for maintenance (in HOA Off mode).

Example 2: The same lift station, two-level switches, three-pump configuration (R1←R2←R3) as in Example 1 except the delay time is set for 1 hour. When the high level switch closes, the R1 pump is activated. If the high-high level switch closes, the R2 pump is also activated. If the tank level remains above the high-high level switch for another 1 hour, the R3 pump is activated. When D2 opens, R3 is turned off. When D1 opens, both R2 and R1 are turned off. In this configuration, the R3 pump serves not only as a backup in case one of the pumps is down for maintenance, but also provides additional capacity should it be needed.

Advanced Functionality

The examples listed above detail the control behavior if wear leveling or output activation modes are enabled. The features are implemented independently. Wear Leveling modes are used to determine which output(s) are activated. Output Activation modes determine how many output(s) are activated at one time. More advanced output control strategies can be implemented when these features are used in combination.

Example: In a two-pump scenario, the Lead output (R1) is set for On/Off control of pH with a setpoint of 8.50, deadband of 0.20 and a “force lower” control direction. The Lag output (R2) has a setpoint of 9.00 and a deadband of 0.20. Time unbalanced (80/20) wear leveling is selected with a cycle time of 15 minutes. When the pH goes above 8.50, the on-times for each pump are evaluated. If R1 has been on less than 80% of the total time for the two pumps, it is energized. Otherwise, R2 has been on for less than 20% of the total time, so it is energized. If the pH remains above the deadband and does not exceed the second setpoint ($8.30 < \text{pH} < 9.00$), the pump selection is re-evaluated every 15 minutes and, if warranted, the pump in operation is switched. If the pH proceeds to exceed 9.00, both pumps are energized and wear leveling is no longer a consideration. When the pH fails to below 8.80, the pump on-times are again evaluated and the appropriate pump is turned off.

Note that while this control is quite powerful, it might cause confusion with users because the setpoints entered for a specific pump within the Lead Lag group may not coincide with the setpoints used to activate that particular pump during operation. The information shown on the Details pages for each pump should be sufficient to minimize this ambiguity.

Control Mode Conflicts

Some control modes are incompatible with Lag output functionality because of an interactive relationship between the output and one or more linked inputs:

- Intermittent Sampling – This control mode places a linked sensor into a Hold state during most of its operational cycle
- Probe Wash – This control mode places one or two linked sensors into a Hold state when a wash cycle is in progress and for a specified Hold period afterward

The link between the output and the sensor input(s) cannot be easily transferred to other outputs, so these types of control modes cannot be designated as Lead output for a Lead Lag group. Outputs configured with these types of control modes are not included on the selection list presented for Lead output. Also, the control mode of an output that is the Lead output for a Lead Lag group cannot be changed to one of these types. If selected, the controller will be unable to save the change and an error message will be added to system log.

Output Details

The details for this type of output include the relay on/off state, relay status (HOA mode, Interlock from sensor calibration, probe wash, or other condition), the current cycle and the total on-times, alarms related to this output, the output defined as the Lead of the group, the output that is the Last Lag output of the group, the number of outputs currently energized within the group, the elapsed time since the last change in the number of outputs energized, the elapsed time since the last wear leveling evaluation, the type of output, and the current control mode setting.

Settings

Touch the Settings icon to view or change the settings related to the relay.

The Lag control mode output defined as the Last Lag within the Lead Lag group offers settings to define the parameters controlling operation of the entire group.

All Lag mode outputs that are not the Last Lag output in the Lead Lag group (those that are selected as a Lead output from another Lag mode output) offer a more limited list of settings.

Lag Settings (Menus with * are shown only in the Last Lag output settings)

HOA Setting	Select Hand, Off or Auto mode by touching the desired mode
Lead	Select the output that will be the lead output for this relay
Wear Leveling*	Select the wear leveling scheme to use. Refer to the detailed description above.
Wear Cycle Time*	This setting only appears if Time Balanced or Time Unbalanced Wear Leveling has been selected above. Enter the amount of elapsed time before time on totals for each output are reevaluated for wear leveling.
Activation Mode*	This entry is only appears if the control mode of the Lead output is On/Off, Dual Setpoint, Spike or Manual. Select one of the options that will determine if and when an additional output will be activated if the primary output is unable to reach the setpoint.
Set point	This setting only appears if the control mode of the Lead output is On/Off or Dual Setpoint and the Activation Mode above is Setpoint Based. Enter the process value for the input assigned to the Lead output that will trigger an additional output to activate.
Set point 2	This setting only appears if the control mode of the Lead output is Dual Setpoint and the Activation Mode above is Setpoint Based. Enter the process value for the input assigned to the Lead output that will trigger an additional output to activate.
Deadband	This setting only appears if the control mode of the Lead output is On/Off or Dual Setpoint and the Activation Mode above is Setpoint Based. Enter the sensor process value away from the set point(s) at which the relay will deactivate.
Delay Time*	This setting only appears if the control mode of the Lead output is On/Off, Dual Setpoint, Spike or Manual. Enter the amount of time, if any, to delay the activation of the output.

Activate With Channels	This setting only appears if the control mode of the Lead output is Manual and the activation mode is Switch Based. Select one or more digital input and/or relay output channels that, if activated, will also activate the Lag output
Reset Time Total	Enter this menu to clear the accumulated time that the output has been activated . This value is used for Time Balanced or Time Unbalanced wear leveling.
Output Time Limit	Enter the maximum amount of time that the relay can be continuously activated. Once the time limit is reached, the relay will deactivate until the Reset Output Timeout menu is entered.
Reset Output Timeout	Enter this menu to clear an Output Timeout alarm and allow the relay to control the process again.
Name	The name used to identify the relay may be changed.
Mode	Select the desired control mode for the output.

Several standard settings that are available for most control modes are not available for Lag outputs. These features affect the entire Lead Lag group and can be specified only within the Lead output's settings. The settings for these fields are propagated down through the entire Lead Lag group when changed for the Lead output. Although the settings for these fields are identical for all outputs in the Lead Lag group, the handling by each Lag output may be independent or group-managed.

Below are the settings that are in the Lead Relay settings that will affect the Lead Lag group:

Interlock Channels	Select the relays and digital inputs that will interlock this relay and all others in the group.
Min Relay Cycle	Enter the number of seconds that will be minimum amount of time that each relay in the group will be in the active or inactive state. Normally this will be set to 0, but if using a motorized ball valve that takes time to open and close, set this high enough that the valve has time to complete its movement.
Hand Time Limit	Enter the amount of time that each relay in the group will activate for when it is in Hand mode.
Hand Output	This menu only appears for pulse relay or analog output Lead outputs. Enter the output % desired for each output in the group when the output is in Hand mode.
Off Mode Output	This menu only appears for analog output Lead outputs. Enter the output mA value desired for each output in the group when the output is in Off mode, or being Interlocked, or during a calibration of the sensor being used as an input. The acceptable range is 0 to 21 mA.
Error Output	This menu only appears for analog output Lead outputs. Enter the output mA desired for each output in the group when the sensor is not giving the controller a valid signal. The acceptable range is 0 to 21 mA.

The **Activate With Channels** setting, normally available for all outputs, is **not** propagated through the Lead Lag group. This field can be entered independently for each Lag Output when the control mode of the Lead output is Manual and the activation mode is Switch Based.

Most other settings for the various types of Lead control modes are managed independently from other outputs within a Lead Lag group. In most cases, no **Activation Mode** settings are available, so the Lead output determines the status for the entire group based on its settings and the current controller parameters. However, when an Activation Mode is enabled, the handling of some settings may require some additional explanation. For example,

- Duty Cycle - If a Lead output with a control mode of On/Off or Dual Setpoint has a Duty Cycle setting of less than 100%, this cycle will be managed for the Lead output only. The Duty Cycle will drive other Lag outputs for Backup or Wear Leveling purposes. However, if additional Lag Output(s) are energized due to Setpoint-Based or Time-Based Activation Mode settings, the additional outputs will operate independently of

- the Duty Cycle setting. The Lead output will continue to cycle On and Off, however, the additional outputs will remain activated with 100% duty cycle until the setpoint deadband is satisfied.
- On Delay / Off Delay - If the Lead output with a control mode of On/Off, Dual Setpoint, or Manual has either an On or Off Delay Time setting specified, the delay will be managed for the Lead output only. If one or more Lag outputs provide Backup or Wear Leveling support, the Delay Times would also effect these outputs. However, if additional Lag Output(s) are energized due to Activation Mode settings, the additional outputs will operate independently of the On or Off Delay Time setting(s) and will energize and de-energize without delay when needed.

5.3.20 Analog Output, Retransmit Mode

Output Details

The details for this type of output include the output %, HOA mode or Interlock status, accumulated on-time, alarms related to this output, current cycle on time, relay type and the current control mode setting.

Settings

Touch the Settings icon to view or change the settings related to the relay.

4 mA Value	Enter the process value to correspond to a 4 mA output signal.
20 mA Value	Enter the process value to correspond to a 20 mA output signal.
Hand Output	Enter the output % desired when the output is in Hand mode.
Error Output	Enter the output % desired when the input signal is invalid (Error mode).
Input	Select the sensor input to retransmit.

5.3.21 Analog Output, Proportional Control Mode

Output Details

The details for this type of output include the output %, HOA mode or Interlock status, accumulated on-time, alarms related to this output, current cycle on time, relay type and the current control mode setting.

Settings

Touch the Settings icon to view or change the settings related to the relay.

Set point	Enter the sensor process value at which the output % will be the programmed minimum %.
Proportional Band	Enter the sensor process value away from the set point at which the output % will be the programmed maximum %.
Minimum Output	Enter the lowest output %. If the output should be off at the set point, this will be 0%.
Maximum Output	Enter the highest output %.
Hand Output	Enter the output % desired when the output is in Hand mode.
Off Mode Output	Enter the output mA value desired when the output is in Off mode, or being Interlocked, or during a calibration of the sensor being used as an input. The acceptable range is 0 to 21 mA.
Error Output	Enter the output mA desired when the sensor is not giving the controller a valid signal. The acceptable range is 0 to 21 mA.
Input	Select the sensor input to use for proportional control.
Direction	Select the control direction.

5.3.22 Analog or Relay Output, PID Control Mode

ONLY AVAILABLE IF CONTROLLER INCLUDES PULSE OUTPUT OR ANALOG OUTPUT HARDWARE & HVAC MODE IS DISABLED

The PID algorithm controls an analog output using standard Proportional-Integral-Derivative control logic. The algorithm provides feedback control based on an error value continuously calculated as the difference between a measured process variable and a desired set point. Tuning settings specify the response for proportional (the size of

the error), integral (the time that the error has been present), and derivative (the rate of change for the error) parameters. With proper tuning, the PID control algorithm can hold the process value close the set point while minimizing overshoot and undershoot.

Normalized Error

The error value versus set point that is calculated by the controller is normalized and represented as percent of full scale. As a result, tuning parameters entered by the user are not dependent upon the scale of the process variable and the PID response with similar settings will be more consistent even when using different types of sensor inputs.

The scale used to normalize the error is dependent upon the type of sensor selected. By default, the full nominal range of the sensor is used. This range is editable by the user if tighter control is desired.

PID Equation Formats

The controller supports two different forms of the PID equation as specified by the Gain Form setting. The two forms require different units for entry of the PID tuning parameters.

Standard

The standard form is more commonly used in industry because its time-based settings for the integral and derivative coefficients are more meaningful. This form is selected by default.

Parameter	Description	Units
K_p	Gain	unitless
T_i	Integral Time	seconds or seconds/repeat
T_d	Derivative Gain	seconds

$$Output (\%) = K_p \left[e(t) + \frac{1}{T_i} \int e(t)dt + T_d \frac{de(t)}{dt} \right]$$

Parameter	Description	Units
$e(t)$	Current Error	% of full scale
dt	Delta Time Between Readings	seconds
$de(t)$	Difference Between Current Error & Previous Error	% of full scale

Parallel

The parallel form allows the user to enter all parameters as Gains. In all cases, larger gain values result in faster output response. This form is used in the WebMaster controller and is used internally by the Control Module.

Parameter	Description	Units
K_p	Proportional Gain	unitless
K_i	Integral Gain	1/ seconds
K_d	Derivative Gain	seconds

$$Output (\%) = K_p e(t) + K_i \int e(t)dt + K_d \frac{de(t)}{dt}$$

Integral Value Management

To determine the integral component of the PID calculation, the controller software must maintain a running total of the accumulated area under the error curve (Current Integral). The sign of the value added to the accumulated

Current Integral during each cycle may be positive or negative based on the current Direction setting as well as the relative values of the current process reading and the set point.

Override Control

The Current Integral accumulates when the output is set to Auto mode. If the controller is switched to Off mode, the value no longer accumulates, but it is not cleared. Therefore, PID control will resume where it left off if the controller is switched from Off back to Auto. Similarly, accumulation of the Control Integral will be suspended if the output is interlocked and resume after the lock-out is removed.

Bumpless Transfer

When the output is switched from Hand to Auto mode, the controller calculates a value for the Current Integral using the current error to generate the same output percent as the Hand Output setting. This calculation does not use the Derivative tuning setting to minimize errors from momentary fluctuations in the input signal. This feature ensures a smooth transition from manual to automatic control with minimal overshoot or undershoot as long as the user sets the Hand Output percentage close to the value that the process is expected to require for optimal control in Auto mode.

Wind-up Suppression

The Current Integral value that is accumulating while the output is set to Auto can become very large or very small if the process value remains on the same side of the set point for a prolonged period of time. However, the controller may not be able to continue to respond if its output is already set to the minimum or maximum limits (0-100% by default). This condition is referred to as Control Wind-Up and can result severe overshoot or undershoot after a prolonged upset has ended.

For example, if the process value remains far below the set point despite a control output being pinned at 100%, the Current Integral will continue to accumulate errors (wind-up). When the process value finally rises to above the set point, negative errors will begin to decrease the Current Integral value. However, the value may remain large enough to keep the output at 100% long after the set point is satisfied. The controller will overshoot the set point and the process value will continue to rise.

To optimize system recovery after wind-up situations, the controller suppresses updates to the Current Integral that would drive the output beyond its minimum or maximum limit. Ideally, the PID parameters will be tuned and the control elements (pump, valves, etc.) will be sized properly so that the output never reaches its minimum or maximum limit during normal control operations. But with this wind-up suppression feature, overshoot will be minimized should that situation occur.

Output Details

The details for this type of output include the analog output value in %, HOA mode or Interlock status, input value, current integral, current and accumulated on-times, alarms related to this output, and the current control mode setting.

Set Point	Numeric entry of a process value used as a target for PID control. The default value, units and display format (number of decimal places) used during data entry are defined based on the Input channel setting selected.
Gain	When the Gain Form setting is Standard, this unitless value is multiplied by the total of the proportional, integral, and derivative terms to determine the calculated output percent.
Proportional Gain	When the Gain Form setting is Parallel, this unitless value is multiplied by the normalized error (current process value versus set point) to determine the proportional component of the calculated output percent.
Integral Time	When the Gain Form setting is Standard, this value is divided into the integral of the normalized error (area under the error curve), then multiplied by the Gain to determine the integral component of the calculated output percent.
Integral Gain	When the Gain Form setting is Parallel, this value is multiplied by the integral of the normalized error (area under the error curve) to determine the integral component of the calculated output percent.
Derivative Time	When the Gain Form setting is Standard, this value is multiplied by the change in error between the current reading and the previous reading, then multiplied by the Gain to determine the derivative component of the calculated output percent.

Derivative Gain	When the Gain Form setting is Parallel, this value is multiplied by the change in error between the current reading and the previous reading to determine the derivative component of the calculated output percent.
Reset PID Integral	The PID Integral Value is a running total of the accumulated area under the error curve (Current Integral). When this menu option is selected, this total is set to zero and the PID algorithm is reset to its initial state.
Minimum Output	Enter the lowest possible output value (normally 0%).
Maximum Output	Enter the highest possible output value as a percentage.
Off Mode Output	Enter the output mA value desired when the output is in Off mode, or being Interlocked, or if the Output Time Limit has expired, or during a calibration of the sensor being used as an input. Also if there is a Probe Wash programmed for the sensor, and the Sensor Mode option is set to Disable the output during the Wash cycle (if the Sensor Mode option is set to Hold the output holds its last setting and the Integral is not updated during the Wash). The acceptable range is 0 to 21 mA.
Error Output	Enter the output mA desired when the sensor is not giving the controller a valid signal. The acceptable range is 0 to 21 mA.
Input	Select the sensor to be used by this output.
Direction	Set the control direction. This setting is used to determine the sign of the calculated error (current process value versus set point) and allows flexible control with only positive values for all PID tuning parameters.
Input Minimum	The low end of the sensor input range, used to normalize errors into percent of full scale units. These values are set to the nominal range of the selected input sensor by default.
Input Maximum	The high end of the sensor input range, used to normalize errors into percent of full scale units. These values are set to the nominal range of the selected input sensor by default.
Gain Form	Select the PID Equation Format used to enter tuning parameters.

5.3.23 Analog Output, Manual Mode

Output Details

The details for this type of output include the analog output %, HOA mode or Interlock status, accumulated on-time, alarms related to this output, current cycle on time, and the current control mode setting.

Settings

A Manual analog output will activate if the HOA mode is Hand, or if it is Activated With another channel. There are no additional programmable parameters

5.3.24 Analog or Relay Output, Flow Proportional Mode

ONLY AVAILABLE IF CONTROLLER INCLUDES PULSE OUTPUT OR ANALOG OUTPUT HARDWARE

Overview

In Flow Proportional control mode, the controller monitors the rate of flow through an analog or digital flow meter, and continuously adjusts the analog output proportional band to achieve a target PPM level.

The user enters the target PPM and the data necessary to calculate the proportional band (the water flow rate at which the maximum pulse rate will occur) required to maintain the target PPM with that flow rate of water.

$$\% \text{ output} = \frac{\text{Target PPM} \times \text{Water Flow Rate (liter/min or gal/min)}}{\text{Cycles} \times \text{Pump Capacity (liter or gal/hr)} \times \text{Pump Setting (\%)} \times \text{Specific Gravity} \times 166.67}$$

$$\% \text{ output} = \frac{\text{Target PPM} \times \text{Water Flow Rate (m}^3\text{/min)}}{\text{Cycles} \times \text{Pump Capacity (liter/hr)} \times \text{Pump Setting (\%)} \times \text{Specific Gravity} \times 0.16667}$$

Control Operation

If the output is continuously on for longer than the Output Time Limit, then output will deactivate.

Output Details

The details for this type of output include the output %, HOA mode or Interlock status, alarms related to this output, current cycle on time, total accumulated on-time, cycles of concentration, mA output, and the current control mode setting.

Settings

Touch the Settings icon to view or change the settings related to the relay.

Target	Enter the desired PPM set point for the product.
Pump Capacity	Enter the maximum flow rate for the metering pump.
Pump Setting	Enter the stroke length setting for the metering pump, in percent.
Specific Gravity	Enter the specific gravity of the product to be added.
Hand Output	Enter the output % desired when the output is in Hand mode.
Off Mode Output	Enter the output mA value desired when the output is in Off mode, or being Interlocked, or during a calibration of the sensor being used as an input. The acceptable range is 0 to 21 mA.
Error Output	Enter the output mA desired when the sensor is not giving the controller a valid signal. The acceptable range is 0 to 21 mA.
Flow Input	Select the flow meter to be used as an input for this control relay.

5.4 Configuration Menu

The configuration Settings Menu is used for settings and activities that are not tied to Inputs or Outputs.

5.4.1 Global Settings

Date	Enter the current year, month and day.
Time	Enter the current hour (military time), minute, and second.
Name	Enter the name to help identify the controller when it connects to Fluent.
Location	Enter the location to help identify the controller when it connects to Fluent.
Global Units	Select the units to be used for cable length and wire gauge settings, metric or Imperial.
Temperature Units	Select between Fahrenheit and Celsius.
Alarm Delay	Enter how much time to wait after powering up the controller before alarm conditions are considered valid.
Pump Units	Select between liters/hour, gallons/hour, or ml/minute.
Language	Select the language the software will use.

5.4.2 Security Settings

Controller Log Out	When Security is Enabled, and after the password has been entered, the controller requires immediate use of a password to calibrate or change settings. Once finished making changes, log out to prevent unauthorized changes by someone else. If not manually logged out, the controller will automatically log out after 10 minutes of inactivity.
Security	Select Enable to require a password in order to calibrate or change settings, or Disable to allow calibration and set point changes without a password. In order to enable security, the default password must be entered first, then touch Enabled, then touch the Confirm icon.

Local Password	Used to change the touchscreen password needed for full configuration capability if security has been enabled. The default local password is 5555. This can and should be changed using this menu if Security is enabled.
-----------------------	---

5.4.3 Ethernet Settings

DHCP Setting	Select Enabled to get an IP address from the LAN or Disabled to use a fixed IP address.
Controller IP Address	Enter the default IP address to use if a network is not available or if DHCP is disabled.
Network Netmask	Enter the default netmask to use if a network is not available or if DHCP is disabled.
Network Gateway	Enter the default gateway address to use if a network is not available or if DHCP is disabled.
DNS Server	Enter the default DNS server IP address to use if DHCP is disabled.
Webserver	Select between the Light color background and the Dark color background
Webserver Mode	Select between HTTPS (recommended, web pages will be encrypted), HTTP (web pages will not be encrypted) and Disabled (no web pages will be served).
SSL Certificate	Only appears if Webserver Mode is HTTPS. Select between Default Cert (which uses a self-signed Walchem certificate) or Upload PEM which provides a way to enter a certificate of the network IT administrator's choice.
DNS Name	Only appears if Webserver Mode is HTTPS and Default Cert is selected. The network IT administrator can map the controller numeric IP to a domain name, which reduces the warning messages that occur when a self-signed certificate is detected by the browser.
Import SSL Private Key File	Only appears if Webserver Mode is HTTPS and Upload PEM is selected. Insert a USB stick containing the desired Private Key file. The files must be named private.key, and must be in the root folder on the stick. Enter this menu to import the file from the stick onto the controller. If the network IT administrator is installing their own certificates, they must install a server private key and a server certificate.
Import SSL Server Certificate File	Only appears if Webserver Mode is HTTPS and Upload PEM is selected. Insert a USB stick containing the desired Private Key file. The files must be named server.crt, and must be in the root folder on the stick. Enter this menu to import the file from the stick onto the controller. If the network IT administrator is installing their own certificates, they must install a server private key and a server certificate.
Import SSL Root Certificate File	Only appears if Webserver Mode is HTTPS and Upload PEM is selected. Insert a USB stick containing the desired Private Key file. The files must be named root.crt, and must be in the root folder on the stick. Enter this menu to import the file from the stick onto the controller. If the network IT administrator is installing a file linked to a trusted certificate authority, then they import the Root Certificate that documents the path or chain of trust that links the server certificate to an authority, in addition to the private key and server certificate.
Apply SSL Certificate Files	Only appears if Webserver Mode is HTTPS. Once the Default Cert has been selected, or the PEM files are imported, the network IT administrator touches "Apply SSL Certificate Files" to force a restart of the webservice and start using the desired certificate.

Delete SSL Certificate Files	Only appears if Webserver Mode is HTTPS and Upload PEM is selected. Once files have been applied, if changes need to be made and different files need to be imported, the network IT administrator touches “Delete SSL Certificate Files” to permanently remove all imported files.
Web Page Color Scheme	Select between the Light color background and the Dark color background
Fluent Alarm Delay	Enter the number of minutes to delay in sending out a Fluent Comms Error message if a data packet is not successfully sent. In order to delay at all, the time must exceed the Update Period time.

5.4.4 Ethernet Details

The Ethernet Details are for information only and display the network settings currently in use, and the recent history of the Fluent connection.

Alarms	Displays any active Network-related alarms
DHCP Status	Displays if the connection to the LAN using DHCP was successful or not.
Controller IP Address	Displays the IP address that the controller is currently using.
Network Netmask	Displays the netmask address that the controller is currently using.
Network Gateway	Displays the gateway address that the controller is currently using.
DNS Server	Displays the DNS server address that the controller is currently using.
MAC Address	Displays the MAC address of the Ethernet card.
Last Fluent Config	Displays the date and time of the last attempt to send configuration data to the Fluent server.
Last Fluent Data	Displays the date and time of the last attempt to send a data to the Fluent server.

5.4.5 Remote Communications (Modbus and BACnet)

This menu will appear only if one of the optional Remote Communications activation keys has been imported into the controller, either by the factory at the time of ordering, or later using a field activation file.

To add the Remote Communications feature in the field, purchase the activation key file and save it to an USB drive, as the only file stored on the root directory of the stick. Insert the stick into the USB port of the controller. Go to the Configuration Menu, then File Utilities, then Import User Config File. Press the Confirm icon to start the activation process.

The display will report whether the import was successful or not. The activation key file is only valid for the serial number of the controller for which it was purchased.

For a complete description of the Modbus feature and register map, refer to the separate Modbus instruction manual. For a complete description of the BACnet features that are supported refer to the separate BACnet Protocol Implementation Conformance Statement.

Comm Status	Select Modbus or BACnet to enable one of the protocols, or Disabled.
Data Format	Modbus Only. Select to receive Modbus data in Standard (Float) format or Float Inverse format
Device ID	BACnet Only. Enter the device ID for the controller. The default will be based on the controller serial number.
Network	BACnet only, if the dual connection WiFi card is installed. Select the connection that will be used for BACnet communications; Ethernet or WiFi.
Data Port	The standard port for Modbus data is port 502, and for BACnet is 47808. Enter the port used if it is non-standard.

Verbose Logging	If logging is Enabled, all Modbus or BACnet requests will be logged in the Event Log (any errors, the function called, starting register, number of registers, value of the first register, get object requests). This is useful when first setting up the HMI, but it will quickly fill the Event Log if it is not Disabled during normal operation. The Verbose Logging function will be automatically disabled after power to the controller is cycled.
------------------------	--

5.4.6 Email Report Settings

NOTE: To set up the content of the Graph report, connect using a browser via Ethernet and go to the Graph webpage. See section 6.

Report #1 (through 4)	Enter this menu to activate and set up a report to email, via the menus below:
Report Type	Select the type of report to email: None, Alarm, Datalog, Graph, or Summary (the Home webpage showing a Summary of current conditions).
Email Recipients	Select up to 8 email addresses that reports may be sent to by touching the check box. The addresses are entered in the Email Addresses menu described below.
Repetition	Only appears if Report Type is Datalog, Graph or Summary. Select how frequently to repeat sending the report: None, Hourly, Daily, Weekly or Monthly.
Reports Per Day	Only appears if Report Type is Datalog, Graph or Summary. Only appears if the repetition is set to Hourly. Select the number of reports per day: 2, 3, 4, 6, 8, 12 or 24. The report is sent on the Report Time and then evenly spaced throughout the day.
Day	Only appears if Report Type is Datalog, Graph or Summary. Only appears if the repetition is set to Weekly. Choose the day of the week on which the report will be sent.
Day of Month	Only appears if Report Type is Datalog, Graph or Summary. Only appears if the repetition is set to Monthly. Choose the day of the month on which the report will be sent. If the current month has less days than the number entered, the report will be sent on the last day of the month.
Report Time	Only appears if Report Type is Datalog, Graph or Summary. Only appears if the repetition is set to Daily, Weekly or Monthly. Enter the time of day for the report to be sent.
Log Frequency	Only appears if the Report Type is Datalog. Select the amount of time between data points. The amount of time allowed varies with the repetition of the report.
Alarm Mode	Only appears if Report Type is Alarm. Choose to send emails on All Alarms or only Selected Alarms.
Attach Summary	Only appears if Report Type is Alarm. Select Enabled to receive alarm emails that include the Main Menu webpage as an attachment or Disabled to receive a text-only alarm report email.
Select Alarms	Only appears if Report Type is Alarm. Only appears if the Alarm Mode is set to Selected Alarms. Select an Input or Output channel, System Alarm or Network Alarm, then touch the check box for individual alarms that will trigger an email to the list of recipients. Repeat for as many as desired.
Alarm Delay	Only appears if Report Type is Alarm. Enter how much time to wait after the alarm has been triggered before alarm conditions are considered valid and the email is sent.
Email Addresses	Enter up to 8 email addresses that reports may be sent to.

Email Server	Select the type of email server to be used: Walchem Fluent®, SMTP, ASMTMP, or TLS/SSL. Walchem Fluent and TLS/SSL will only be an available selection if the Network board is 191733-02 or higher (not -01) AND software version is 3.31 or higher (TLS/SSL) or 3.37 (Walchem Fluent). Refer to Config – Controller Details menu for the Network board software version.
SMTP Server	Will not appear if Email Server is Walchem Fluent. Enter the SMTP server address, either numeric or its name.
SMTP Port	Will not appear if Email Server is Walchem Fluent. Walchem Fluent email requires that port 49887 is open. Enter the port to be used by email server. The default is port 25 for SMTP, port 587 for ASMTMP, and port 465 for TLS/SSL
From Address	Enter the controller’s email address. If the email server selected is Walchem Fluent, only enter the portion of the address to be shown before the @ symbol. All emails will be from @ walchem-fluent.net
ASMTMP Username	Enter the username required for authentication. Only appears if the email server type is ASMTMP or TLS/SSL
ASMTMP Password	Enter the password required for authentication. Only appears if the email server type is ASMTMP or TLS/SSL
Test Report Recipients	Select the email addresses from the list that should receive the test report. If there are none, enter them in the Email Addresses menu described above.
Send Email Test Report	Enter this menu and confirm to send the test Summary report to the selected test report recipients.

5.4.7 Display Settings

Edit Home Screen Layout	<p>The Home screen view can be customized to show the desired parameters, in any order, in cards that can be adjusted to the desired size. The largest size card is one half of one screen. A maximum of 6 half-screens can be created. If there are more than two half-screens, the controller will automatically scroll between the screens.</p> <p>To customize a half-screen, touch the <Add Card> icon in the empty screen to create one large card. The <- -> icon splits the card in half, while the <- > <- icon merge two card together. Touching the word in the card brings up a list of all available parameters that may be displayed in that card.</p> <p>The <trash can> icon deletes the entire half-screen. The arrow icons above and below the <trash can> move the half-screen up or down in position relative to other half-screens. A deleted half-screen can be brought back using the <Restore Card> icon.</p> <p>Touch the Confirm icon to accept the changes or Close icon to cancel.</p>
Splash Protection	Enable Splash Protection if the controller will be hosed down or is installed unprotected from rain. Water splashing on the screen can be make the screen respond like it’s being swiped. When enabled, the user will be required to touch a series of numbered buttons in the numerical order to unlock the screen. The screen will return to protected mode after 10 minutes of no activity, or if manually activated.
Activate Splash Protection	Manually active splash protection mode without waiting 10 minutes by touching this menu and confirming that choice.
Adjust Display	Change the contrast and the brightness by touching the arrow keys. If the display becomes unreadable, it is possible to reset the defaults by powering down and pressing the bottom right corner of the touchscreen while powering back on.

Auto Dim Time	If this is set to a non-zero time, the display backlight will dim if the touchscreen is not touched for that amount of time. Touching the screen will turn the back to normal brightness.
Key Beep	Select enable to hear a beep when an icon is pressed, or disable for silence

5.4.8 File Utilities

The File Utilities menu is used to transfer log files, user settings files and software upgrade files, using the local and a USB flash drive stick or using a network connection and browser.

If using a USB drive, it is necessary to choose a quality product, less than 16 MB capacity, with FAT file system.

Files may be renamed, but Configuration and Software Upgrade file extensions must NOT be changed. The USB-drive must contain only one copy of these type of files. If more than one is available, the first one alphabetically will be imported by the controller.

File Transfer Status	Displays the status of the last attempt to export a file
Data Log Range	Select how far back in time for data to be downloaded: Since Previous download, past 6 hours, all the way up to the past 3 months.
Log Frequency	Select the amount of time between data points. The amount of time allowed varies with the Data Log Range. If the Data Log Range is selected as Since Previous download, the choices for frequency of data points will be limited by how far back in time the last download occurred.
Export Data Log File	Save the Data Log file, as defined by the Data Log Range and Log Frequency settings above, to a USB stick.
Export Event Log	Save the Event Log file to a USB stick. This records set point changes, user calibrations, alarms, relay state changes, file exports, etc.
Export System Log	Save the System Log file to a USB stick. This records hardware changes, software upgrades, automatic calibrations, power loss, system-level issues, etc.
Export User Config File	The User Configuration file contains all settings for the controller. Enter this menu to save the controller's settings to a USB stick (or download the file to a computer if using the web interface) for using later to restore settings to this controller, or to program additional controllers with the same settings as this one. It may take several minutes to create the file and transfer it.
Import User Config File	The User Configuration file contains all settings for the controller. Insert a USB stick (if using the local interface) containing the desired Configuration file. Enter this menu to import the file from the stick onto the controller. If using the web interface, click Upload and select the file to upload.
Repair Network File System	Touch this menu and confirm in order to clean up the file system on the Ethernet card.
Restore Default Config	Enter this menu to restore all of the settings to the factory default values. Any changes to settings that were previously made will be lost!
Software Upgrade	Insert a USB stick that has the upgrade file stored in the root directory into the USB connector under the watertight cap on the outside of the front panel (see figure 19). Touch the Confirm icon, and then touch the Confirm icon to start the upgrade.

NOTE: To maintain the NEMA 4X/IP66, always remove the stick and replace the cap securely over the USB connector when not in use.

5.4.9 Controller Details

Controller	Displays the name for the group of default settings used as built
Product Name	Displays the model of the controller as built

Serial Number	Displays the serial number of the controller
Controller Board	Displays the revision number of the front panel circuit board
Software Version	Displays the software version on the controller board
Power Board	Displays the revision number of the power/relay board
Sensor Board #1	Displays the revision number of the sensor board in the Sensor 1 slot
Software Version	Displays the software version on the sensor board in the Sensor 1 slot
Sensor Board #2	Displays the revision number of the sensor board in the Sensor 2 slot
Software Version	Displays the software version on the sensor board in the Sensor 2 slot
Network Board	Displays the revision number of the network board
Software Version	Displays the software version on the network board
AO Board	Displays the revision number of the analog output board
Last Data Log	Displays the date and time of the last data log download
Battery Power	Displays the VDC output of the battery that is used to hold the date and time. The acceptable range is 2.4-3.2 VDC.
Processor Temp	Displays the temperature of the main processor. The acceptable range is -10 to 65 C.
I/O Card 1 Temp	Displays the temperature of the sensor input processor installed in I/O slot 1. The acceptable range is -10 to 65 C.
I/O Card 2 Temp	Displays the temperature of the sensor input processor installed in I/O slot 2. The acceptable range is -10 to 65 C.
Network Temp	Displays the temperature of the network card processor. The acceptable range is -10 to 65 C.
+5 Volt Supply	The normal range is 4.75 to 5.25 VDC. The 5 V supply is used for powering all the I/O.
+3.3 Volt Supply	The normal range is 3.135 to 3.465 VDC. The 3V supply is used to run the system.

5.5 HOA Menu



The HOA (Hand-Off-Automatic) Menu is used to quickly and easily test all relay outputs, and to stop or enable automatic control.



Swipe up or down to view the output to change. Touch the Hand, Off or Auto button to change the HOA state of that output. The current HOA state will be shaded dark. The change happens immediately unless the output is a relay which has a Minimum Relay Cycle programmed above 0 seconds.

5.6 Graph Menu



The Graph Menu is used to display a graph containing two sensor or analog input values plus one digital input or relay state. Touch the Graph icon and the controller will display “Generating Graph Please Stand By” for a few seconds then show the graph. The default is to show the value of sensor input S11 and the state of relay output R1 over the past 10 minutes.

Touching any point on either line on the graphs displays a vertical line plus the details for that data point: date and time, value of the sensor, and an arrow showing if the state or the digital input/relay was high or low at that time. In this view, <left arrow> and <right arrow> icons appear and touch these moves the vertical line by one data point in that direction. Touch the Close icon to return to the normal graph view.

Touching the  or the  icons will redraw the graph forward or backwards in time, in increments of one time range. It can only go back in time to the point where the data log file used to generate the graph starts. Changing the time frame while in the graph view, after moving back in time, shows data from that past time. Exiting the graph menu and returning to the graph menu moves back to the current time.

Swiping the graph left or right with two fingers is another way to move the graph forward or backwards in time. An alternate way to change the time frame of the graph is to pinch or spread two fingers.

Settings

Touch any of the parameter tabs on the top of the graph to access graph settings.

Left Sensor	Enter this menu to select the sensor, analog input, flowmeter type digital input (total flow and/or flow rate if applicable), or analog output value to show on the the left side of the graph
Low Axis Limit	The graph auto-scales based on the sensor value if both Low and High Axis Limit are set to 0. To manually adjust the left Y axis scale, enter the low limit here.
High Axis Limit	The graph auto-scales based on the sensor value if both Low and High Axis Limit are set to 0. To manually adjust the left Y axis scale, enter the high limit here.
DI/Relay	Enter this menu to select digital input, or analog output value to show on the graph
Right Sensor	Enter this menu to select the sensor, analog input, flowmeter type digital input (total flow and/or flow rate if applicable), or analog output value to show on the right side of the graph
Low Axis Limit	The graph auto-scales based on the sensor value if both Low and High Axis Limit are set to 0. To manually adjust the right Y axis scale, enter the low limit here.
High Axis Limit	The graph auto-scales based on the sensor value if both Low and High Axis Limit are set to 0. To manually adjust the right Y axis scale, enter the high limit here.
Time Range	Select the time range for the X axis of the graph. The time range may also be accessed from the graph view by touching the time range icon in the lower right corner.

The resolution of the screen only allows for 180 data points per graph, so not all data points in each time range can be shown. For finer resolution, download the data log CSV file from the Config – File Utilities menu and graph the data in Excel or equivalent spreadsheet application.

Time Range	Time between data points	Datalog file used
10 minutes	10 seconds	Daily
30 minutes	30 seconds	Daily
1 hour	1 minute	Daily
2½ hours	2 minutes	Weekly
8 hours	6 minutes	Weekly
½ day	10 minutes	Weekly
1 day	20 minutes	Weekly
½ week	1 hour	Monthly
1 week	2 hours	Monthly
2 weeks	4 hours	Monthly
4 week	8 hours	Monthly

6.0 OPERATION using Ethernet

All of the same settings that are available using the touchscreen are also available using a browser that is connected to the controller’s Ethernet IP address. The controller may be connected to a Local Area Network (LAN), directly to the Ethernet port of a computer, or to the Fluent account management system server.

6.1 Connecting to a LAN

Connect the controller’s network card to the LAN using a CAT5 cable with RJ45 connector.

6.1.1 Using DHCP

Using the touchscreen, from the Main menu, touch Config, then touch Network Settings, then touch DHCP Setting. Touch Enabled, then the Confirm icon.

After a power cycle of the controller, return to Config, then Network Details to view the Controller IP Address that has been assigned to the controller by the network.

6.1.2 Using a fixed IP Address

Using the touchscreen, from the Main menu, touch Config, then touch Network Settings, then touch DHCP Setting. Touch Disabled, then the Confirm icon. Cycle power to the controller. If DHCP is already Disabled then you can skip this step.

Using the touchscreen, from the Main menu, touch Config, then touch Network Settings, then touch Controller IP Address. Enter the IP address provided by the administrator of the LAN then touch the Confirm icon. Repeat for the Network Netmask and Network Gateway settings. Cycle power to the controller.

6.2 Connecting Directly to a Computer

Connect the controller's network card to the computer using a CAT5 cable with RJ45 connector.

Follow the instructions above to give the controller a fixed IP address that is compatible with the network settings of the computer.

Open a browser and type the numeric Controller IP address in the web page address field. The login screen should quickly appear. Once logged in, the Home page will appear.

The default username is admin and the default password is the 10-digit serial number for the controller. The serial number can be found printed on the label on the side of the controller, or by using the local touchscreen and going to the Config menu, then Controller Details.

Once logged in with the default password, a prompt will appear to change to new credentials. The option to close the prompt window and continue using the existing credentials exists, however the Admin and View-Only level usernames and passwords can and should be changed by browsing to the Config menu, Security Settings webpage. Log into the page using the current Admin level username and password, then change to new ones.

6.3 Navigating the web pages

From any computer that is directly connected to the controller, or is on the same network as the controller, open a browser and type the numeric Controller IP address in the web page address field. The login screen should quickly appear.

The default username is admin and the default password is the 10-digit serial number for the controller. The serial number can be found printed on the label on the side of the controller, or by using the local touchscreen and going to the Config menu, then Controller Details.

Once logged in with the default password, a prompt will appear to change to new credentials. The option to close the prompt window and continue using the existing credentials exists, however the Admin and View-Only level usernames and passwords can and should be changed by browsing to the Config menu, Security Settings webpage. Log into the page using the current Admin level username and password, then change to new ones.

After logging in, the Home page will appear. This will display the date and time, any active alarms, and the current readings or status of all of the Inputs and Outputs. On the left side of the page you will see links to the Main Menu selections: Alarms, Inputs, Outputs, Graphs, Config, Notepad and Software Upgrade if available. Click each menu to see the submenus, and click on the submenu to access all of the details and settings associated with it. At the bottom, there is a manual logout.

Below the Main Menu links there may be links to the instruction manual, Walchem website, and Walchem Fluent website, that are useful if the controller is connected to the Internet.

At the bottom there is a Log Out link. The Ethernet connection only supports four simultaneous users. If users do not log out, their session will stay active until it times out (the time is set in the Security menu), and other users may be denied access until an existing session closes.

6.4 Graphs Webpage

The graphs page can display up to 8 parameters at a time. All possible parameters available based upon the controller programming are listed in one column. Click the right arrow to add the highlighted parameter to the Selected column, or the left arrow to move a selected parameter back out. Use the up and down arrows to move the highlighted selected parameter up and down the list to set the order of the graphs on the page.

Select the Time Range for the X-Axis of the graph from the pulldown list, from 1 Hour to 4 Weeks.

Click the Refresh Graph button  to display the changes.

If you are setting up a Graph Report email, click Save For Report to set the current page settings as the ones to be used for the report. You will want to make sure that the selected Time Range is at least as long as the Report Frequency set in the Email Report menu.

You can then change the settings on the graphs webpage without changing the report settings, by clicking the refresh button without clicking the Save For Report button. The graph page will be greyed out until the refresh button has been clicked.

In order to see what the report settings are, click the Load Report Settings button.

The graph email will contain an html attachment showing the graphs. The Export Graph button can be used to save the graphs as an image that can be copied to a document. The same button is also available directly from the Graphs webpage.

The graphs will display the parameter's data in 360 data points, equally spread over the time range, in a blue line. For analog inputs and outputs, the minimum value, maximum value, and average value over that same time range are also displayed and graphed in a yellow line. The Y-axis will auto-scale to fit the data.

To change the Y-axis scale to a custom range, click anywhere on the axis, enter the desired minimum and maximum values, click Save, and then click the refresh graph button. To return to auto-ranging, click the Y-axis, click Set Defaults, and refresh.

6.5 Software Upgrade

The software upgrade link will appear only to users with Admin login, and only if the controller has access to the Internet with TCP port 9013 open inbound and outbound and the controller software is currently at version 3.31 or higher, and the software is not at the latest version available. The hardware to support remote software upgrades is only available in controllers with front panel controller boards built after June 12, 2018 (rev. D).

An Upgrade Description link to a webpage that supplies more details on the content of the upgrade is also available.

Click on Start Upgrade to begin the upgrade process.

The Upgrade Status will be displayed, with a button that may be used to Cancel the upgrade. Upon confirmation to cancel the upgrade, a Resume button will appear.

The status messages include:

Preparing controller for upgrade

Then if successful: Complete

Or not successful: Failed

Downloading upgrade file (showing number of bytes downloaded of total number of bytes)

Then if successful: Complete

Or not successful: Failed

Validating upgrade file

Then if successful: Complete

Or not successful: Failed

Upgrade in progress (showing each individual step in the upgrade installation)

When the upgrade installation is complete, the login webpage will appear. Status or error messages will be recorded in the System Log.

6.6 Notepad Menu



The Notepad Menu is used to store up to 10,240 bytes of notes (approximately one byte per character for English language). This is typically used to communicate or store important process changes or events. A byte counter in the lower right-hand corner displays how much space remains.

Click Save Notes and do not navigate away from the webpage until the popup screen indicates that changes have been accepted. If the size is too large, you can click Clear Notes, which is noted in the Event Log, or delete some text and then save.

6.7 Remote Sensor Calibration

For each sensor input, a Sensor Calibration is available on the input's webpage. To initiate a sensor calibration, click on the One-Point Process Calibration button.

A popup will open that displays the current value for that input and allow entry of the new value. Type the value of that parameter as determined by another meter or laboratory analysis and click Begin Calibration. Click Cancel to abort the calibration and retain the previous calibration.

For input types using automatic temperature compensation, the temperature reading will be displayed until the reading is stable and then move to the next step without any action required.

If successful, the calibration gain or offset will be displayed. Click Save to accept the new value or Cancel to retain the previous calibration.

If the new value results in a gain or offset that is out of the allowable range for the input, Calibration Failed will be displayed. Click OK to end the calibration and retain the previous calibration settings. Refer to section 8.1 Calibration Failure for help troubleshooting each type of sensor.

7.0 MAINTENANCE

The controller itself requires very little maintenance. Wipe with a damp cloth. Do not spray down the controller unless the enclosure door is closed and latched and the USB port cap is installed hand-tight.

7.1 Copper or Nickel Sensor Cleaning

NOTE: The controller must be recalibrated after cleaning the sensor.

Frequency

The sensor should be cleaned periodically. The frequency required will vary by installation. In a new installation, it is recommended that the sensor be cleaned only if a 1-Point Calibration cannot be successfully performed.

Cleaning Procedure

The most important maintenance item for the sensor is to keep the optical paths clean of plate-out or other coatings. In electroless applications, the sensor should be etched when the tank is etched, or when ever plate-out is evident. If plate-out does occur in the sample line or sensor, etch the system as you would the tank.

Avoid any mechanical cleaning of the optical surfaces to avoid scratching them. Chemical cleaning is preferred over mechanical cleaning methods. Plate-out should be removed using nitric acid or a persulfate or peroxide/sulfuric etch.

7.2 pH Electrode Maintenance

The pH electrode requires periodic cleaning and calibration. These electrodes are like batteries and their voltage outputs will change with time even if they are not being used. After installation, the rate of change increases, and factors such as temperature, extremes of pH, abrasion and chemical attack will increase the required frequency of calibration. If the process solution contains oils, scale or other solids, the electrode surfaces will tend to coat, its response time will slow down and cleaning will be required.

The frequency of cleaning and calibrating will vary greatly depending upon the application, the factors listed above, as well as the accuracy of control you require. The best way to determine the optimum number of days between calibrations is to remove the electrode from the process periodically (weekly in clean water applications, daily in dirty or hot applications) and check its accuracy in a buffer solution. If using manual temperature compensation, remember to change the temperature from that of the process to that of the buffer. If the accuracy of the reading is within your required tolerances, and the speed of response is good, replace the electrode in the process. If not, clean the electrode and perform a two point calibration.

The method of cleaning the electrode will depend upon the coating, as well as the materials of construction of the electrode. Do not use a solvent that will attack the electrode! Care must be taken to avoid scratching the pH electrode's glass, as this will shorten its life.

Oily coatings should be removed with a mild detergent or isopropyl alcohol. Hard scales such as calcium carbonate can usually be removed with a dilute hydrochloric acid solution. Soft coatings can be removed using a soft cloth or soft toothbrush.

A two point calibration should always be performed after cleaning the electrode. ^[P]_[SEP]
Because the electrode signal is so sensitive, the condition of the cable and connectors between the electrode, preamplifier and controller is critical. Make sure that all electrical connections stay clean and dry. Never splice the cable prior to preamplification. Replace the cable if there is any sign of damage.

8.0 TROUBLESHOOTING



CAUTION: Disconnect power to the controller before opening front panel!

Troubleshooting and repair of a malfunctioning controller should only be attempted by qualified personnel using cau-

tion to ensure safety and limit unnecessary further damage. Contact the factory.

8.1 Calibration Failure

Calibrations will fail if the adjustments to the reading are outside of the normal range for a properly functioning system. Refer to the instruction manual for the specific sensor being used for further information.

8.1.1 Copper or Nickel Sensors

The calibration offset will fail if the adjustment is outside of -10 to +10.

Possible Cause	Corrective Action
Dirty sensor	Clean or etch sensor
Water/Sample Calibration has not been performed, or performed incorrectly	Perform a Water/Sample Calibration
Condensation inside sensor	Allow sensor to dry out. Replace desiccant.
Faulty sensor cable or photodetector	Repair or replace sensor
Faulty sensor receptacle on controller	Replace

8.1.2 pH Sensors

The calibration will fail if the adjustment to the gain is outside of 0.2 to 1.2, or if the calculated offset is outside of -140 to 140.

Possible Cause	Corrective Action
Dirty electrode	Clean electrode
Improper wiring of sensor to controller	Correct wiring
Incorrect temperature reading or setting	Ensure that the temperature is accurate
Incorrect cable length or wire gauge setting	Set to the correct values
Faulty electrode	Replace electrode
Faulty preamplifier	Replace preamplifier

8.1.3 Contacting Conductivity Sensors

The calibration will fail if the adjustment to the gain is outside of 0.5 to 2.0.

Possible Cause	Corrective Action
Dirty electrode	Clean electrode
Improper wiring of sensor to controller	Correct wiring
Wrong cell constant entered	Program the controller cell constant setting at the value that matches the electrode being used
Incorrect temperature reading or setting	Ensure that the temperature is accurate
Incorrect cable length or wire gauge setting	Set to the correct values
Faulty electrode	Replace electrode

8.1.4 Electrodeless Conductivity Sensors

The calibration will fail if the adjustment to the gain is outside of 0.2 to 10, or the offset is outside of -10,000 to 10,000.

Possible Cause	Corrective Action
Dirty sensor	Clean sensor
Improper wiring of sensor to controller	Correct wiring
Sensor placed too close to container walls	Relocate sensor

Sensor placed in the direct path of electrical current flow	Relocate sensor
Incorrect temperature reading or setting	Ensure that the temperature is accurate
Incorrect cable length or wire gauge setting	Set to the correct values
Faulty sensor	Replace sensor

8.1.5 ORP Sensors

The calibration will fail if the adjustment to the gain is outside of 0.5 to 1.5, or if the calculated offset is outside of -300 to 300.

Possible Cause	Corrective Action
Dirty electrode	Clean electrode
Improper wiring of sensor to controller	Correct wiring
Faulty electrode	Replace electrode
Faulty preamplifier	Replace preamplifier

8.1.6 Disinfection Sensors

The calibration will fail if the adjustment to the gain is outside of 0.2 to 10.0, or if the calculated offset is outside of -40 to 40.

Possible Cause	Corrective Action
Insufficient conditioning	Wait for the appropriate amount of time before attempting a calibration.
Insufficient sample flow	Increase flow rate to between 30 and 100 liter per hour.
Air bubbles on membrane	Dislodge bubbles. Adjust flow rate higher if necessary.
Air bubbles in electrolyte	Refill membrane cap with electrolyte.
Dirty membrane	Clean membrane
Loose membrane cap	Tighten membrane cap.
Faulty membrane	Replace membrane cap.
High Pressure	Reduce pressure to below 1 atmosphere and refill cap with electrolyte
No electrolyte fill solution in membrane cap	Fill membrane cap with electrolyte. Replace membrane cap if it will not hold solution.
Improper wiring of sensor to controller	Correct wiring
Faulty sensor	Replace sensor
Faulty analysis equipment or reagents	Consult test equipment instructions
Sample contaminated with interfering molecule (refer to Sensitivity specification in sensor instructions)	Remove source of contamination

8.1.7 Analog Inputs

The calibration will fail if the adjustment to the gain is outside of 0.5 to 2.0, or if the calculated offset is outside of -2 to 2 mA.

Possible Cause	Corrective Action
Improper wiring of sensor to controller	Correct wiring
Faulty sensor	Replace sensor

8.1.8 Temperature Sensors

The calibration will fail if the calculated offset is outside of -10 to 10.

Possible Cause	Corrective Action
Improper wiring of sensor to controller	Correct wiring
Temperature input is set to the incorrect element	Reprogram to match the connected temperature element
Faulty sensor	Replace sensor

8.2 Alarm Messages

NO SAMPLE

No Sample will be displayed if the measurement signals indicate excess air in the sample. In the Input Details menu, both the Sample Measurement and Sample Reference mV will be between 0.4 and 0.7 times what the readings were in water during the last Water/Sample Calibration (Water Measurement and Water Reference mV).

Liquid level too low for immersible sensor	Raise level or lower sensor
Sample pump failure	Repair or replace sample pump
Leak in or blockage of the sample line	Repair sample line
Excess air in sample tubing	Purge sample line of air. Check for leaks. Check orientation of sensor. Make sure sample line inlet is not placed where there is air or gas in the tank.
Contamination of the bath	A chemical in the bath may be absorbing at the reference wavelength. Test the sensor in a sample of uncontaminated copper solution.
Faulty sensor	Repair or replace sensor
Controller is faulty	Repair or replace controller

LAMP OUT

Lamp Out will be displayed if the measurement signals indicate almost no light getting through. In the Input Details menu, both the Sample Measurement and Sample Reference mV will be less than 0.01 times what the readings were in water during the last Water/Sample Calibration (Water Measurement and Water Reference mV).

Possible Cause	Corrective Action
Sensor wire(s) disconnected	Reconnect.
Lamp failure	Replace lamp
Dirty sensor	Clean or etch sensor
Faulty sensor	Repair or replace sensor.
Controller is faulty	Repair or replace controller

PLATE OUT

Plate Out will be displayed if the measurement signals indicate very light getting through. In the Input Details menu, both the Sample Measurement and Sample Reference mV will be less than 0.4 times what the readings were in water during the last Water/Sample Calibration (Water Measurement and Water Reference mV).

Water/Sample Calibration has not been performed, or performed incorrectly	Perform a Water/Sample Calibration
Dirty sensor	Clean or etch sensor
Faulty sensor receptacle on controller	Replace
Faulty sensor	Repair or replace sensor
Controller is faulty	Repair or replace controller

HIGH or HIGH-HIGH ALARM

Occurs if the sensor reading rises above the high alarm set points. If your unit is programmed for an alarm relay output, the alarm relay will activate. The controller will continue to check the sensor reading, and any outputs using the sensor will remain active.

Possible Cause	Corrective Action
The process went further out of control than normal.	May have to increase chemical flow rate.
The chemical supply has run out.	Replenish the chemical supply.
The pump or valve or supply line is faulty.	Repair or replace the control device.

Wrong chemical is being controlled.	Replace with correct chemical.
The sensor is not responding to changes.	Repair or replace sensor. Evaluate mixing or recirculation.
The pump is siphoning, valve leaking.	Repair or replace the control device or re-route tubing.
Control output has been left in "HAND" mode.	Switch back to "AUTO".
It may be a normal part of the process.	None required.

LOW or LOW-LOW ALARM
Occurs if the sensor reading drops below the low alarm set points. If your unit is programmed for an alarm relay output, the alarm relay will activate. The controller will continue to check the sensor reading, and any outputs using the sensor will remain active.

Possible Cause	Corrective Action
The process went further out of control than normal.	May have to increase chemical flow rate.
The chemical supply has run out.	Replenish the chemical supply.
The pump or valve or supply line is faulty.	Repair or replace the control device.
Wrong chemical is being controlled.	Replace with correct chemical.
The sensor is not responding to changes.	Repair or replace sensor. Evaluate mixing or recirculation.
The pump is siphoning, valve leaking.	Repair or replace the control device or re-route tubing.
Control output has been left in "HAND" mode.	Switch back to "AUTO".
It may be a normal part of the process.	None required.

DI STATE CUSTOM MESSAGE
A digital input that is a DI State type can be set such that either the open or closed state generates an alarm. The alarm message may be customized. The most common use for this will be a Flow Switch.

Possible Cause	Corrective Action
No flow	Check piping for closed valves, blockage, etc. Check recirculation pump.
Faulty flow switch/cable	Check with ohmmeter.
Faulty controller	Check by shorting digital input in controller.

TOTAL ALARM
Occurs if the flow meter or feed monitor totalizer alarm limit is exceeded.

Possible Cause	Corrective Action
Normal operation	Reset the total to clear alarm, or wait for the automatic total reset to occur.
AC coupled onto flow meter cable	Route cable at least 6 inches (150 mm) away from any AC voltage
Noise coupled onto flow meter cable	Shield cable

RANGE ALARM (for flow meter or feed monitor type digital inputs)
Occurs if the flow meter or feed monitor accumulated total is too large. The maximum total is 1 trillion times the increment of the device. For example, if the increment is one gallon per pulse the maximum total is 1 trillion gallons.

Possible Cause	Corrective Action
Normal operation	Reset the total to clear alarm, or wait for the automatic total reset to occur.

FLOW VERIFY
Occurs if the feed monitor digital input does not register any contacts while the control output for that pump has been active for longer than the Flow Alarm Delay time.

Possible Cause	Corrective Action
Metering pump has lost prime	Re-prime metering pump
Faulty metering pump	Repair or replace metering pump
Incorrect feed monitoring device wiring	Correct wiring. Make sure that digital input that the feed monitoring device is connected to has been assigned to the correct relay
Faulty feed monitoring sensor	Replace feed monitoring sensor
Blown fuse	Verify the pump is getting power. Replace fuse
Faulty output relay	Replace relay board
Faulty digital input	Verify that feed monitoring device is making contact closures using an ohmmeter. If OK, and connected properly, replace the controller circuit board.

OUTPUT TIMEOUT	
This error condition will stop control. It is caused by the output (either relay or analog) being activated for longer than the programmed Time Limit.	
Possible Cause	Corrective Action
The process went further out of control than normal.	Increase time limit or reset timer.
The chemical supply has run out.	Replenish the chemical supply.
The pump or valve or supply line is faulty.	Repair or replace the control device.
Wrong chemical is being controlled.	Replace with correct chemical.
The sensor is not responding to changes.	Replace sensor. Evaluate mixing or recirculation.
RANGE ALARM (for sensor inputs)	
It indicates that the signal from the sensor is out of the normal range. This error condition will stop control of any output using the sensor. This prevents controlling based upon a false sensor reading. If the temperature sensor goes into range alarm, then the controller will go into manual temperature compensation using the Default Temperature setting.	
Possible Cause	Corrective Action
Sensor wires shorted	Disconnect short
Faulty sensor	Replace sensor
Faulty controller	Replace or repair controller
EVENT SKIPPED ALARM	
An event skipped alarm is set when a second timer event occurs while one event is still running. An event skipped alarm is also set when the timer relay never turns on during an event because of an interlock condition. The alarm is cleared when the relay is next activated for any reason (the next timer event or HAND mode or “activate with” force on condition).	
Possible Cause	Corrective Action
Incorrect programming	Reprogram to eliminate overlapping events
Long duration interlock condition	Normal operation
SENSOR FAULT	
This error indicates that the signal from the sensor is no longer valid at all. This error condition will stop control of any output using the sensor.	
Possible Cause	Correction Action
Sensor wires shorted	Disconnect short
Faulty sensor	Replace sensor
Faulty controller	Replace or repair controller
INPUT FAILURE	
This alarm indicates that the sensor input circuit is no longer working, or that one of the inputs used to calculate a virtual input is in a Sensor Fault condition. This error condition will stop control of any output using the input.	
Possible Cause	Correction Action
Faulty controller	Replace or repair controller
If using virtual inputs, sensor fault of one of the inputs	See Sensor Fault troubleshooting above
BATTERY POWER LOW	
This alarm indicates that the battery which holds the date and time in memory is below 2.4 VDC.	
Possible Cause	Correction Action
Faulty battery	Replace battery
SYSTEM TEMP LOW	
This alarm indicates that the temperature inside the controller is below -10 °C.	
Possible Cause	Correction Action
Low ambient temperatures	Provide heat for the controller
SYSTEM TEMP HIGH	
This alarm indicates that the temperature of the controller or sensor processor IC is above 75 °C, or that the temperature of the Ethernet card processor IC is above 85 °C.	
Possible Cause	Correction Action
High ambient temperatures	Provide cooling for the controller
High power draw	Do not use the controller’s 24VDC to power more than 1.5W total

DISPLAY ERROR	
This alarm occurs if the user interface gets lost	
Possible Cause	Correction Action
Pressing icons very quickly	Exit out of the screen and continue programming
N ETWORK CARD FAILURE	
This alarm occurs if the Ethernet circuit board fails	
Possible Cause	Correction Action
Ethernet card locked up	Try a power cycle to reset it
Ethernet card not seated correctly	Unplug the network card and plug it back in
Faulty Ethernet card	Replace Ethernet card
WEB SERVER FAILURE	
This alarm occurs if the web server on the Ethernet circuit board fails	
Possible Cause	Correction Action
Web server locked up	Try a power cycle to reset it
Faulty Ethernet card	Replace Ethernet card
Fluent DATA COMM ERROR	
This alarm occurs if the controller attempts to send data to Fluent and Fluent fails to acknowledge receipt of the data	
Possible Cause	Correction Action
No connection to LAN	Connect Ethernet cable to LAN
Wrong IP, subnet and/or gateway address	Program valid settings for LAN in the controller or use DHCP if supported by the LAN
LAN is blocking outside access	Program LAN's router to open access
Network card failure	See above
SENSOR CAL REQUIRED	
This alarm occurs if the sensor's Cal Reminder Alarm has been set to more than 0 days and if the sensor has not been calibrated within that number of days	
Possible Cause	Correction Action
Time to calibrate	Calibrate the sensor
Reminder set in error	Set the Cal Reminder Alarm to 0
CALCULATION ERROR	
This alarm occurs if a virtual input calculation cannot be completed, for example if it has to divide by zero.	
Possible Cause	Correction Action
Zero value for the input used as the denominator	Calibrate or evaluate that input
DI FLOW VERIFY	
This alarm occurs if the control output is on but the associate flow verification device is not registering flow	
Possible Cause	Correction Action
Metering pump has lost prime	Re-prime metering pump
Faulty metering pump	Repair or replace pump
Faulty verification device wiring	Correct wiring
Wrong digital input assigned to the output	Correct programming error
Faulty verification device	Repair or replace device
Faulty wiring of output to pump	Correct wiring
Faulty output board	Repair or replace board
Faulty digital input	Replace board
CONTROLLER, POWER, DISPLAY, OR SENSOR BOARD ERROR	
This alarm occurs if the board listed is not recognized	
Possible Cause	Correction Action
Poor ribbon cable connection	Remove and reseat ribbon cable, cycle power
Poor option card connection	Remove and reseat the board, cycle power

Faulty board	Return the controller for repair
CONTROLLER, POWER, SENSOR, DISPLAY, NETWORK OR ANALOG OUTPUT BOARD VARIANT	
This alarm occurs if the type of board that is detected is not a valid type	
Possible Cause	Correction Action
Poor ribbon cable connection	Reseat ribbon cable
Faulty ribbon cable	Replace ribbon cable
Faulty Board	Replace the board listed in the error message
SENSOR SOFTWARE VERSION	
This alarm occurs if a sensor input card with software v2.11 or lower is installed onto a controller board running software v2.13 or higher	
Possible Cause	Correction Action
Software is not compatible between boards	Perform a Software Upgrade
NETWORK SOFTWARE VERSION	
This alarm occurs if an Ethernet card is installed onto a controller board running a higher software version than the Ethernet card	
Possible Cause	Correction Action
Software is not compatible between boards	Perform a Software Upgrade
INVALID SENSOR TYPE	
This alarm occurs if the programmed sensor type is not possible for the installed sensor board	
Possible Cause	Correction Action
The sensor board has been removed and replaced with a different type	Reinstall the correct board or reprogram the input to a valid type for the board installed
INVALID CONTROL MODE	
This alarm occurs if the programmed control mode is not possible for the installed power relay board	
Possible Cause	Correction Action
The power relay board has been removed and replaced with an incorrect model	Reinstall the correct board or reprogram the output to a valid type for the board installed
Fluent LIVE CONNECT ERROR	
This alarm occurs if the controller is unable to establish an encrypted connection to the Fluent server. If there is also a Fluent Data Comm Error, fix that first.	
Possible Cause	Correction Action
No UDP support on Port 9012 or TCP support on Port 44965	Open ports/protocols on router
DISABLED (SENSOR, DIGITAL OR VIRTUAL INPUT; RELAY OR ANALOG OUTPUT)	
This alarm occurs if software for that input or output did not start correctly	
Possible Cause	Correction Action
The software is not functioning	If the error message clears on its own, no action is required. If the error message persists, cycle power. If the error message still persists, return the controller for repair.
RELAY OR ANALOG OUTPUT CONTROL FAILURE	
This alarm occurs if software for that output did not run correctly	
Possible Cause	Correction Action
The software is not functioning	If the error message clears on its own, no action is required. If the error message persists, cycle power. If the error message still persists, return the controller for repair.
FRAM FILE SYSTEM ERROR	
This alarm occurs if the FRAM is not detected at power up	
Possible Cause	Correction Action
The FRAM was or is not functioning	If the error message clears on its own, no action is required. If the error message persists, cycle power. If the error message still persists, replace the controller board.

8.3 Procedure for Evaluation of Conductivity Electrode

Try cleaning the electrode first (refer to Sect. 7.1). To check the electrode, check the electrode connections to the

terminal strip (refer to Figure 7). Make sure that the correct colors go to the correct terminals, and that the connections are tight. Restore power and see if the conductivity is back to normal. If not, replace the electrode.

8.4 Procedure for evaluation of the pH/ORP electrode

The most common cause of a calibration failure is an electrode problem. First try cleaning the electrode, then retry the calibration. If this fails again, replace the electrode and retry the calibration.

The next most common problem is wet or poor connections. Check the connection of the electrode to the cable for moisture. Check the connections between the cable and the terminal strip. Make sure that they are tight, that the terminal is not clamped to the plastic jacket, and that the wires are routed to the correct terminal. If there is a junction box installed between the electrode and the controller, check the wiring there as well.

You should be able to measure the +5VDC \pm 5% and -5VDC \pm 5% vs IN- at the terminal strip. If not, the controller is faulty. You should be able to measure the IN+ vs IN- (DC scale) and get the appropriate values for the buffer solutions used. If not, the preamplifier or its wiring is faulty.

The last possibility is to try replacing the preamplifier.

8.5 Diagnostic Lights

Some of the circuit boards inside the controller have diagnostic lights.

CONTROLLER BOARD D1 LED	
Indicates status of the software application. Normal operation is that 5 seconds after power-up, it does one long blink on, two short blinks, on long blink off. If it is not doing this:	
Possible Cause	Correction Action
Controller software is not running	Try a power cycle to reset it
Faulty controller board	Replace controller board
CONTROLLER BOARD D3 LED	
Indicates the status of the 5 VDC power supply. Normal operation is ON. If not on:	
Possible Cause	Correction Action
Faulty ribbon cable	Replace ribbon cable
Faulty power supply	Replace power/relay board
CONTROLLER BOARD D2 LED	
Indicates the status of the 3.3 VDC power supply. Normal operation is ON. If not on:	
Possible Cause	Correction Action
Faulty ribbon cable	Replace ribbon cable
Faulty power supply	Replace power/relay board
SENSOR BOARD LED	
Indicates the status of the sensor board. Blinks slowly for several seconds during power-up. Normal operation is OFF. If not behaving this way:	
Possible Cause	Correction Action
Sensor card locked up	Try a power cycle to reset it
Sensor card not seated correctly	Unplug the card and plug it back in
Faulty sensor card	Replace sensor card
ETHERNET BOARD LED	
Indicates status of the software application. Normal operation is that 5 seconds after power-up, it cycles 5 seconds on, 5 seconds off. If not behaving this way:	
Possible Cause	Correction Action
Network software is not running	Try a power cycle to reset it
Network software file system is corrupt	Go to Config – File Utilities and Repair Network File System
Ethernet card not seated correctly	Unplug the card and plug it back in
Faulty Ethernet board	Replace Ethernet board

9.0 Spare Parts Identification

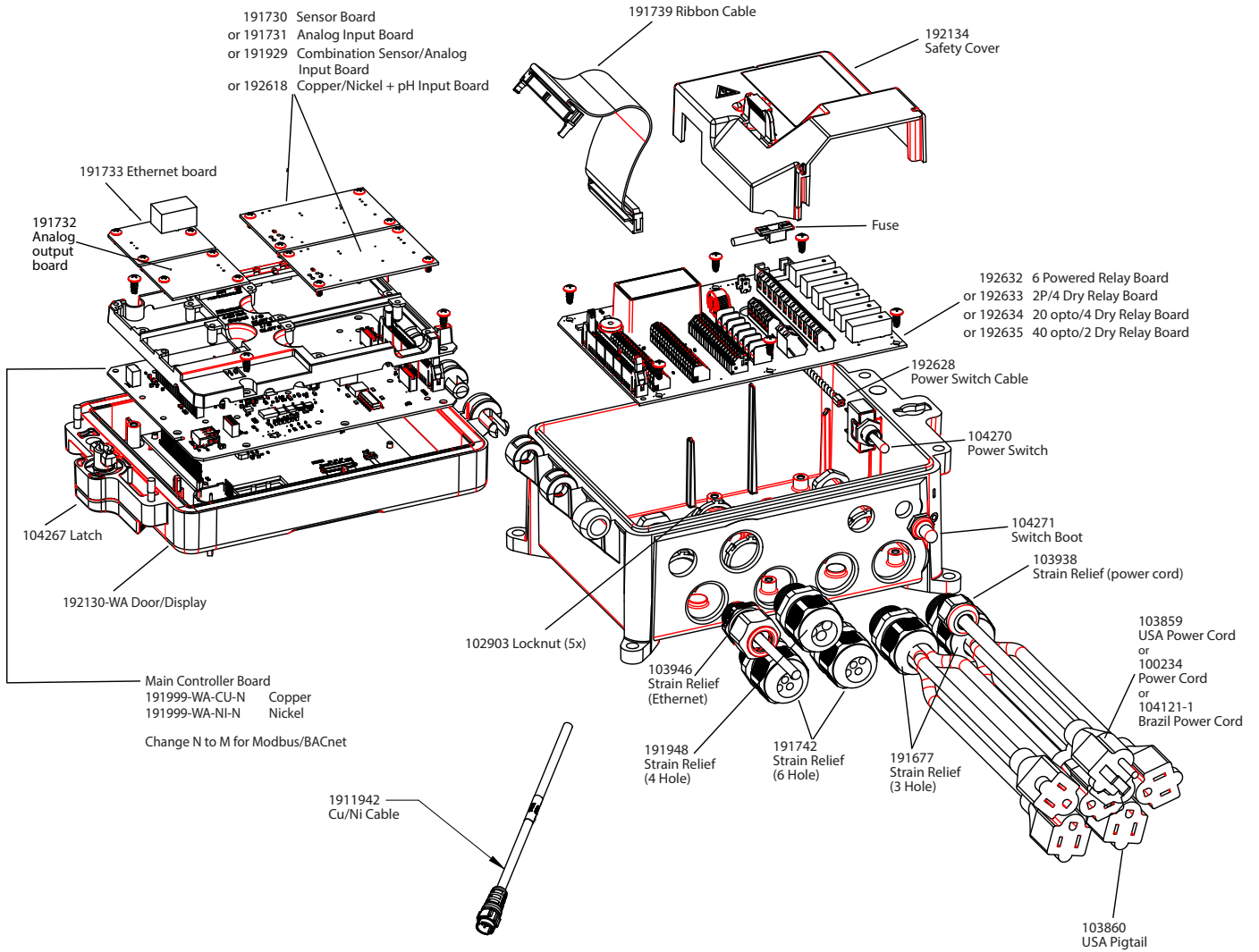

Controller Parts

10.0 Service Policy

Walchem controllers have a 2-year warranty on electronic components and a 1-year warranty on mechanical parts and electrodes. See Statement of Limited Warranty in front of manual for details.

Walchem controllers are supported by a worldwide network of authorized master distributors. Contact your authorized Walchem distributor for troubleshooting support, replacement parts, and service. If a controller is not functioning properly, circuit boards may be available for exchange after the problem has been isolated. Authorized distributors will provide a Return Material Authorization (RMA) number for any products being returned to the factory for repair. Repairs are generally completed in less than one week. Repairs that are returned to the factory by next-day-air freight will receive priority service. Out-of-warranty repairs are charged on a time and material basis.

**FIVE BOYNTON ROAD
TEL: 508-429-1110**

HOPPING BROOK PARK

**HOLLISTON, MA 01746 USA
Web: www.walchem.com**